

# Square D™ QO™ and Homeline™ Load Centers and Enclosures

## Catalog

1100CT0501  
01/2026

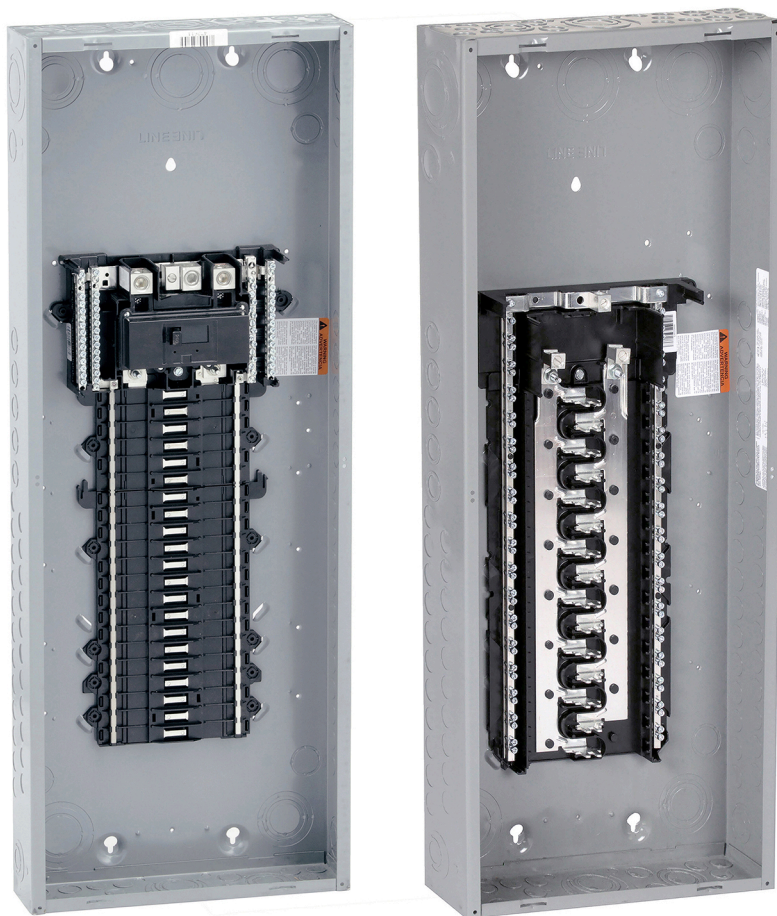

# Legal Information

The information provided in this document contains general descriptions, technical characteristics and/or recommendations related to products/solutions.

This document is not intended as a substitute for a detailed study or operational and site-specific development or schematic plan. It is not to be used for determining suitability or reliability of the products/solutions for specific user applications. It is the duty of any such user to perform or have any professional expert of its choice (integrator, specifier or the like) perform the appropriate and comprehensive risk analysis, evaluation and testing of the products/solutions with respect to the relevant specific application or use thereof.

The Schneider Electric brand and any trademarks of Schneider Electric SE and its subsidiaries referred to in this document are the property of Schneider Electric SE or its subsidiaries. All other brands may be trademarks of their respective owner.

This document and its content are protected under applicable copyright laws and provided for informative use only. No part of this document may be reproduced or transmitted in any form or by any means (electronic, mechanical, photocopying, recording, or otherwise), for any purpose, without the prior written permission of Schneider Electric.

Schneider Electric does not grant any right or license for commercial use of the document or its content, except for a non-exclusive and personal license to consult it on an "as is" basis.

Schneider Electric reserves the right to make changes or updates with respect to or in the content of this document or the format thereof, at any time without notice.

**To the extent permitted by applicable law, no responsibility or liability is assumed by Schneider Electric and its subsidiaries for any errors or omissions in the informational content of this document, as well as any non-intended use or misuse of the content thereof.**

---

# Table of Contents

QO Load Centers .....	5
QO Product Description .....	5
Introduction to QO Load Centers .....	5
Catalog Number Guide – QO Load Centers .....	6
General Information .....	7
QO Indoor and Outdoor Load Centers .....	9
Indoor Enclosures (NEMA Type 1).....	10
Outdoor Enclosures (NEMA Type 3R).....	11
Fixed Mains vs. Convertible Mains – Single Phase .....	12
Fixed Mains vs. Convertible Mains – Three Phase.....	17
QO Plug-on Neutral Load Centers.....	19
QO Standard Load Centers .....	27
QO Label Samples.....	33
QO Wiring Diagrams .....	35
QO Value Packs, Mounting Bases and Covers .....	38
Plug-on Neutral Load Center Value Packs .....	39
QO Mounting Bases – UL Recognized Components .....	41
QO Load Center Covers .....	43
Homeline Load Centers .....	45
Homeline Product Description .....	45
Introduction to Homeline Load Centers .....	45
Catalog Number Guide – Homeline Load Centers .....	46
General Information .....	47
Homeline Indoor and Outdoor Load Centers .....	48
Indoor Enclosures (NEMA Type 1).....	49
Outdoor Enclosures (NEMA Type 3R).....	50
Fixed Mains vs. Convertible Mains – Single Phase .....	51
Technical Information .....	53
Homeline Label Samples.....	60
Homeline Wiring Diagrams .....	61
Homeline Value Packs and Covers .....	62
Plug-on Neutral Load Center Value Packs .....	63
Homeline Load Center Covers .....	66
QO/Homeline Load Centers .....	67
QO vs. Homeline Load Centers .....	67
QO/Homeline Enclosure Dimensions and Knockout Information .....	67
QO/Homeline Bolt-On Hubs.....	71
QO/Homeline Accessories.....	72
QO/Homeline Surge Protective Devices (SPD) .....	78
Enclosed Devices .....	81
Product Description .....	82
Enclosures .....	83
Indoor Enclosures .....	83
Rainproof Enclosures .....	83
Service Entrance Devices .....	84
Non-Service Entrance Devices .....	85



# QO Load Centers

## QO Product Description

### Introduction to QO Load Centers

QO Load Centers are built on the Square D reputation for reliability, innovation, and leadership in circuit protection.

QO Load Centers from Square D are Underwriters Laboratories® (UL®) Listed panelboards. They are designed to meet residential, commercial, and industrial requirements to help protect electrical systems, equipment, and people.



**WARNING:** This product can expose you to chemicals including lead, which is known to the State of California to cause cancer, and lead compounds, which are known to the State of California to cause birth defects or other reproductive harm. For more information go to [www.P65Warnings.ca.gov](http://www.P65Warnings.ca.gov).

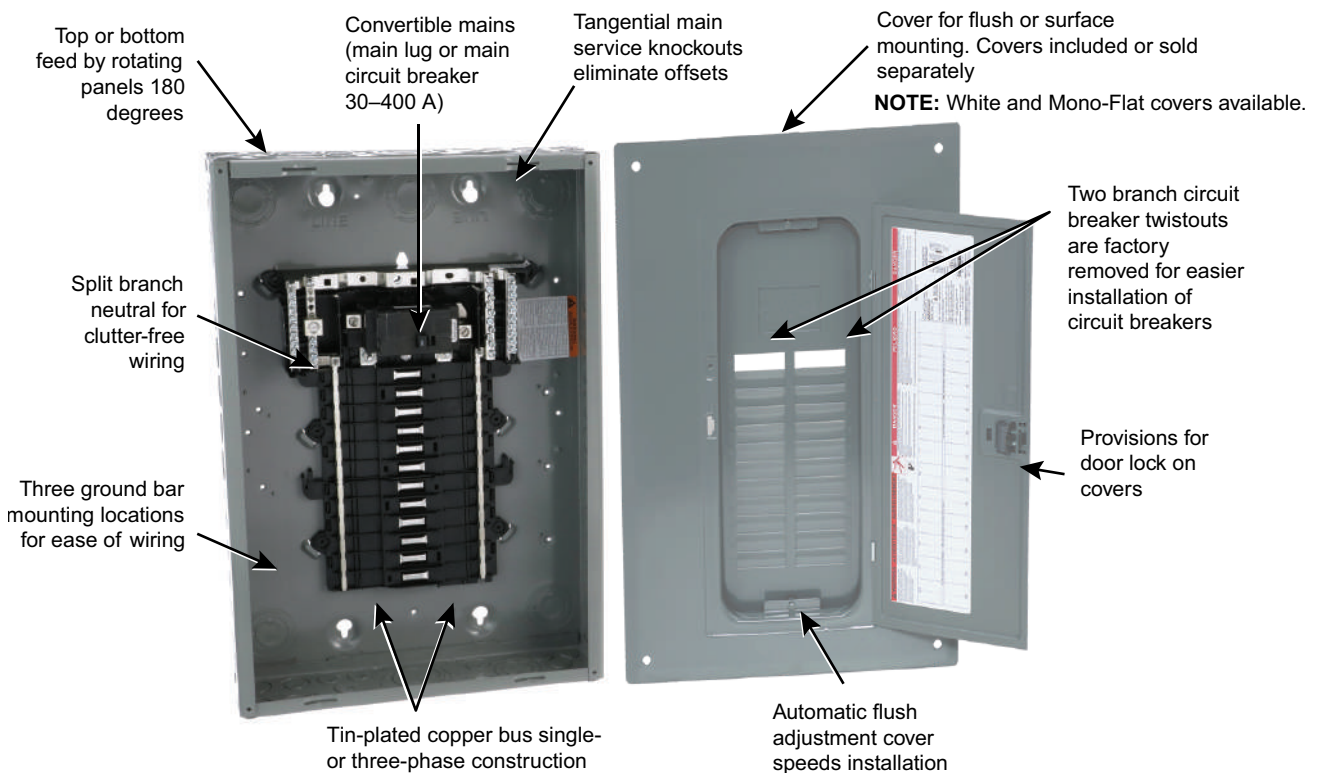

#### Other Features:

- **QO 3/4-inch format:** this space-saving feature saves wire.
- **Backed out neutral screws:** save labor and installation time.
- **Convertible Mains:** allows fast field conversion between main circuit breaker and main lugs to meet changing job requirements.
- **Standard 22 kA / 10 kA AIR SCCR:** standard short-circuit series rating for all main circuit breaker Load Centers provides increased application capability. Main circuit breaker 22 kA / Main lugs or branch circuit breakers 10–65 kA.
- **3-phase:** QO three-phase main circuit breaker panels can be field upgraded to provide up to 100,000 A series connected short circuit current ratings (SCCR).
- **Interior:** single, captive interior mounting screw retained by the interior. Interior mounts can be removed during rough-in for pain or theft protection.
- **Screws:** combination slot / square-drive neutral, ground and cover screw accommodate both standard flat blade screw drivers and square-head drivers.

# Catalog Number Guide – QO Load Centers

Figure 1 - QO Load Centers Catalog Number Guide

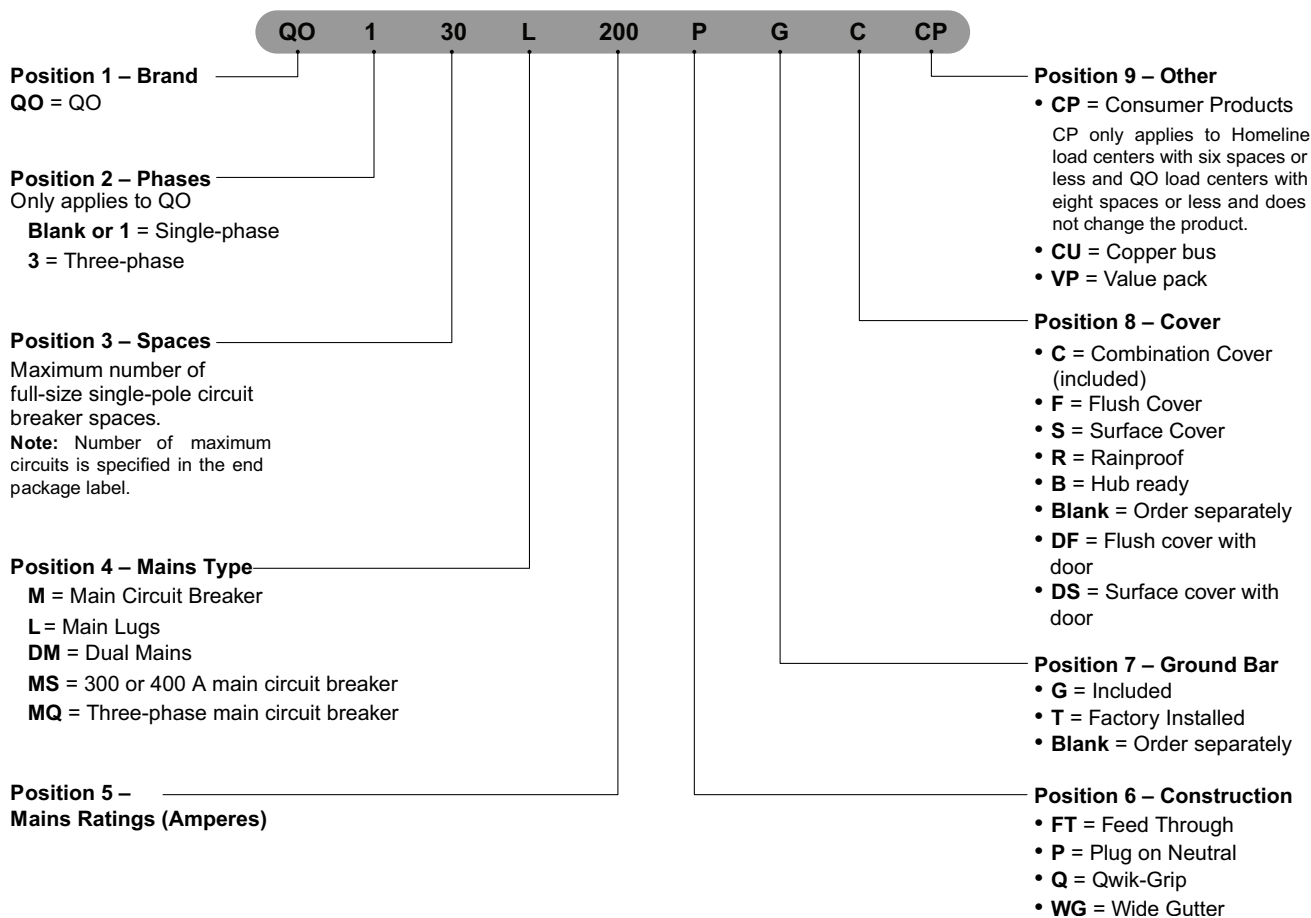
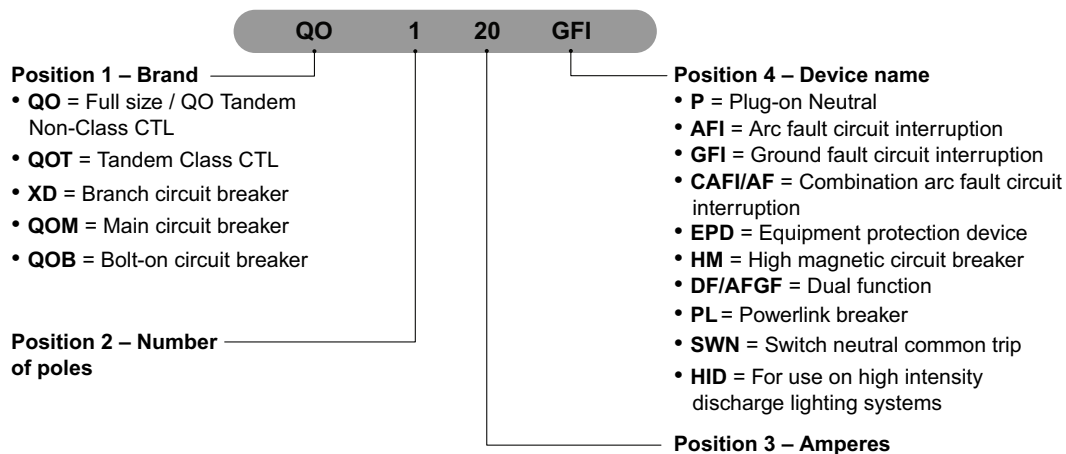
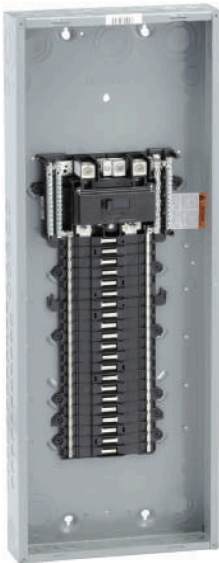

Figure 2 - QO Circuit Breakers Catalog Number Guide



## General Information



QO142M200P



QO330L200G

### Type

Circuit breaker load centers for use on electrical systems are UL Listed under File E-6294 (panelboards) and meet Federal Specifications W-P-115c, Type 1, Class 2 for use in government housing. Select from QO, QOT (non-CTL), QO-PL, QO-GFI (UL Class A ground fault protection), QO-AFI (arc fault circuit interrupter), QO-CAFI (combination arc fault interrupter), or QO-EPD (30 mA equipment ground fault protection) branch circuit breakers.

### Neutral Assemblies

Branch neutral terminals suitable for one #14–4 AWG copper or one #12–4 AWG aluminum wire

Two or three #14-1/0 AWG copper or #12–1/0 AWG aluminum terminals provided on 12–42 circuits, 100–225 A load centers

Suitable lugs provided on the neutrals for termination of the grounding conductor

All unused neutral terminals may be used to terminate bare or green equipment grounding conductors when the load center is used as service equipment:

- one #14–4 AWG copper
- one #12–4 AWG aluminum
- two or three #14–10 AWG copper
- two or three #12–10 AWG aluminum

### Ratings

Single-Phase

Main lugs: 30–400 A

Main circuit breaker: 100–400 A three-phase

Main lugs: 60–225 A

Main circuit breaker: 100–225 A

### UL Listed

- File E-6294 (panelboards)
- UL 67 standard enhances safety in electrical distribution panels suitable for use as service equipment
- Suitable for use with 75°C copper or aluminum main conductors

### Class CTL

UL Listed Class CTL load centers meets the 2020 National Electrical Code® (NEC®) article for lighting and appliance branch circuit panelboards.

**NOTE:** Only applicable on non-plug on neutral load centers.

### Service

120 Vac, 1Ø2W

120/240 Vac, 1Ø3W

240 Vac, 1Ø3W

208Y/120 Vac, 3Ø4W

240/120 Vac delta, 3Ø4W

240 Vac corner grounded delta, 3Ø3W

48 Vdc maximum (1Øconvertible main lug 12–42 circuit only)

**Line Lugs**

All lugs suitable for 75°C copper or aluminum wires.

Main lugs and main circuit breaker load centers have wire binding screw torque values on the wiring diagrams and circuit breaker labels.

**Phasing**

Load centers have distributed phase bussing.

Most branch circuit breakers can be mounted in any position.

**Table 1 - Branch Circuit Breakers**



10,000 AIR	
QO	1-pole, 10–70 A 2-pole, 10–200 A 3-pole, 10–100 A
QOT (Tandems Non-CTL)	1-pole, 15–20 A
QO-EPD	1-pole, 15–30 A 2-pole, 15–60 A
QO-GFI	1-pole, 15–30 A 2-pole, 15–60 A
QO-AFI	1-pole, 15–20 A
QO-CAFI	1-pole, 15–20 A
QO-HID	1-pole, 15–50 A 2-pole, 15–50 A 3-pole, 15–30 A
QO-PL QO-PLILC	1-pole, 10–20 A, 30 A 2-pole, 10–60 A 3-pole, 15–60 A
QO-SWN	2-pole, 10–50 A 3-pole, 10–50 A
22,000 AIR	
QO-VHGFI	1-pole, 15–30 A
QO-VH	1-pole, 15–30 A 2-pole, 15–200 A 3-pole, 15–100 A
QOB-VH	2-pole, 150 A <sup>(1)</sup> 3-pole, 110–150 A <sup>(1)</sup>
42,000 AIR	
QOH	2-pole, 40–125 A
65,000 AIR	
QH	1-pole, 15–30 A 2-pole, 15–30 A 3-pole, 15–30 A

(1) For use with 300 A and 400 A load centers only. Requires PK3CA mounting kit, ordered separately.

## QO Indoor and Outdoor Load Centers

### NEMA Type 1 — Indoor

NEMA 1 enclosures are typically used for protecting controls and terminations from objects and personnel. This style of enclosure, while offering a latching door, does not have a gasketed sealing surface. NEMA 1 enclosures are used in applications where sealing out dust, oil, and water is not required.

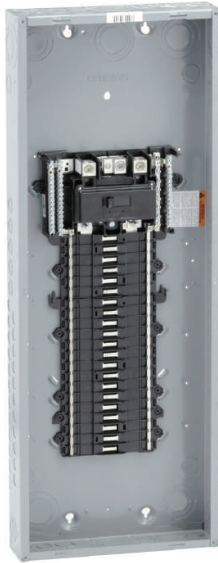

### NEMA Type 3R — Rainproof

NEMA 3R enclosures are typically used in outdoor applications for wiring and junction boxes. This style of enclosure provides protection against falling rain, sleet, snow, and external ice formation. In an indoor application, they protect against dripping water. This style of enclosure does not have a gasketed sealing surface. Some models have hasps for padlocking.



## Indoor Enclosures (NEMA Type 1)



### QO Plug-on Neutral

QO plug-on neutral load centers offer time-savings for plug-on neutral combination arc fault (CAFI) and dual function circuit breaker installation. Our innovative, split neutrals are designed to save you time and wire, allowing plug-on neutral circuit breakers to connect directly to the neutral bar without the pigtail.



### Qwik-Grip wire management system available

Save time and simplify your work by eliminating knockouts, installing wire connectors and blindly pulling wire into the load center.



### Material, Finish and Knockouts

Our enclosures are from sheet steel with knockouts at top, bottom, back and sides. Finish consists of gray baked enamel electrodeposited over cleaned, phosphatized steel. Most 100–225 A indoor enclosures are 14.25 in. (362 mm) wide and 300–400 A indoor enclosures are 20 in. (508 mm) wide. QO enclosures can be rotated to allow top or bottom feed. QO load center interiors have shielded tin plated copper bus bars to ensure superior performance and durability.



### Flush and Surface Covers

Indoor QO covers with latch are available in surface or flush mount and are included with our load centers or purchased separately. Doors to cover circuit breaker handles, except on 2–4, 4–8 and 6–12 circuit models. Triple lead cover screws for fast cover installation.



### Automatic Flush Adjustment

QO flush covers feature a floating, spring-mounted trim providing automatic adjustment. This ensures proper alignment without manual adjustment and speeds up the final installation.



### Filler Plates

Snap-in style filler plates are accessories purchased separately available to cover unused spaces. HOMFP and QOFP filler plates available for branch circuit breaker spaces in all of our covers. QOM1FP filler plates available for 100–125 A convertible load center covers. QOM2FP filler plates available for 150–225 A convertible load center covers.



### Different Colors and Styles

QO covers are available in gray and white colors. Mono-Flat covers, a high-end alternative with aesthetically pleasing design and low profile surface with concealed mounting screws and door hinges are available as an alternative to our standard covers.

## Outdoor Enclosures (NEMA Type 3R)



### QO Plug-on Neutral

QO plug-on neutral load centers offer time-savings for plug-on neutral combination arc fault (CAFI) and dual function circuit breaker installation. Our innovative, split neutrals are designed to save you time and wire, allowing plug-on neutral circuit breakers to connect directly to the neutral bar without the pigtail.



### Material, finish and knockouts

Galvanized steel enclosure includes interior trim and door with a gray baked enamel electrodeposited over cleaned, phosphatized steel. QO load center interiors have tin plated copper bus bars.

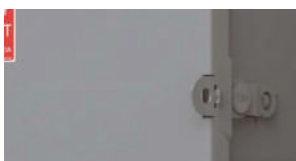

### Stainless steel latch

A stainless steel door latch on the enclosure provides closure and maximum durability.



### Wiring access without door removal

Convertible main panels are side-hinge door devices, providing full wiring access without door removal.





### Bolt-on hubs



NEMA Type 3R devices have provisions for interchangeable bolt-on hub. Square D type rain-tight bolted hubs provide fast and convenient top feed conduit connection. Hubs are available for 0.75 in. (19 mm) to 4 in. (102 mm) conduit size. No gasket is required with hubs from 0.75 in. (19 mm) to 2.50 in. (64 mm) when used on NEMA Type 3R load centers.

## Fixed Mains vs. Convertible Mains – Single Phase

Table 2 - Single-Phase — QO Load Centers, Fixed Mains 30–125 A

Indoor NEMA 1	Rainproof NEMA 3R
<b>Fixed Mains (30–125 A)</b>	
	
<b>Standards</b>	
UL 67 Listed <ul style="list-style-type: none"> <li>• File E-6294</li> <li>• Suitable for use as service equipment in select models</li> <li>• 75°C wire rating</li> </ul>	
<b>Short Circuit Current Rating</b>	
UL short circuit rating depends on lowest interrupting rating of circuit breaker installed.	
<b>Interior</b>	
<ul style="list-style-type: none"> <li>• Tin plated aluminum bus</li> <li>• Tin plated copper bus is an available option on 6–12 and 8–16 circuit load centers</li> <li>• Tin plated copper bus is standard on 4–8 circuit load centers</li> </ul>	
<b>Mains</b>	
<ul style="list-style-type: none"> <li>• Factory-installed main lugs</li> <li>• Top mains positioning only</li> <li>• Top or bottom feed</li> <li>• A backfed main circuit breaker can be field installed in 4–8, 6–12, and 8–16 load centers using PK2MBretaining kit</li> </ul>	
<b>Covers</b>	
Combination flush and surface cover	Cover included
<b>Main Lug Kits</b>	
Not applicable	
<b>Main Circuit Breaker Kits</b>	
Not applicable	
<b>Field-Installable Main Circuit Breaker</b>	
Not Applicable	

**Table 3 - Single-Phase — QO Load Centers, Convertible Mains 100–225 A**

Convertible Mains (100–225 A)		
		
Standards		
UL 67 Listed <ul style="list-style-type: none"> <li>• File E-6294</li> <li>• Suitable for use as service equipment</li> <li>• 75°C wire rating</li> </ul>		
Short Circuit Current Rating		
<ul style="list-style-type: none"> <li>• Main lugs: up to 65,000 AIR (depends on lowest interrupting rating of branch circuit breakers installed)</li> <li>• Main circuit breaker: 22,000 AIR standard</li> <li>• 22,000 AIR main circuit breaker kits</li> </ul>		
Interior		
<ul style="list-style-type: none"> <li>• Shielded, one-piece tin plated copper bus</li> <li>• Removable interior with single, captive mounting screw</li> <li>• Split branch neutral with up to 50% more terminations than required</li> <li>• Multiple mounting locations for equipment grounding bar kits: left, right, and bottom</li> <li>• Main lugs Load Centers have equipment grounding bar kits included (not factory-installed)</li> </ul>		
Mains		
Factory-installed main lugs convertible to main circuit breaker		
Load Center Amperage	Main Circuit Breaker Kit (A)	
125	50–125	
150	100–150	
200	100–200	
225	100–225	
Factory-installed main circuit breaker convertible to main lugs		
Main Circuit Breaker	Main Lug Kit	Load Center (A)
100	125	100
125	125	125
150	225	150
200	225	200
225	225	225
Covers		
<ul style="list-style-type: none"> <li>• Available in surface or flush mount and are included or purchased separately.</li> <li>• Flush covers have spring loaded interior trim for automatic flush adjustment.</li> <li>• Easy to open latch</li> </ul>	Cover included	
Main Lug Kits		
<ul style="list-style-type: none"> <li>• Field-installable in main circuit breaker or main lugs load centers</li> <li>• QOL125kit for use in 100–125 A load centers</li> <li>• QOL225kit for use in 150–225 A load centers</li> </ul>		
Main Circuit Breaker Kits		
<ul style="list-style-type: none"> <li>• Field-installable in main lugs or main circuit breaker load centers</li> <li>• 50–225 A main circuit breaker kit is 22,000 AIR series rated with 10,000 AIR branch circuit breakers</li> </ul>		

**Table 3 - Single-Phase — QO Load Centers, Convertible Mains 100–225 A (Continued)**

Convertible Mains (100–225 A)				
Field-Installable Main Circuit Breaker				
Main Circuit Breaker Rating	Load Center Mains Rating	22,000 AIR Main Circuit Breaker	Lug Wire Size AWG/kcmil Al or Cu	Lug Torque (lb-in. / N•m)
<b>QOM1 Frame Size</b>				
50	100–125 A	QOM50VH	#6–2/0	50 lb-in. (6 N•m)
60	100–125 A	QOM60VH		
70	100–125 A	QOM70VH		
80	100–125 A	QOM80VH		
90	100–125 A	QOM90VH		
100	100–125 A	QOM100VH		
110	125 A	QOM110VH		
125	125 A	QOM125VH		
<b>QOM2 Frame Size <sup>(4), (5)</sup></b>				
100	150–225 A	QOM2100VH	#4–250 Cu #4–300 Al	250 lb-in. (28 N•m)
125	150–225 A	QOM2125VH		
150	150–225 A	QOM2150VH		
175	200–225 A	QOM2175VH		
200	200–225 A	QOM2200VH		
225	225 A	QOM2225VH		

(2) Do not exceed the load center mains rating.

(3) Wire range listed for QOM circuit breaker kits is the wire range of that circuit breaker. To find out maximum wire size permitted in a particular load center per UL, see Main Wire Size in the load center tables.

(4) Add suffix 1021 for shunt trip.

(5) Add suffix 8041 for control wire taps.

**Single-Phase — QO Load Centers, Fixed Mains 300–400 A**

**Standards**

**UL Listed**

- File E-6294
- Suitable for use as service equipment
- 75°C wire rating

**Short circuit current rating**

- Main lugs: up to 65,000 AIR
- Main circuit breaker: 42,000 AIR fully rated

**Interior**

- Available in single-phase construction
- Interiors accept QO and QOB-VH 110–150 A maximum circuit breakers (QOB-VH circuit breakers require connector kit PK3CA)
- Tin plated aluminum bus
- Available in single-phase construction
- Tin plated copper connector fingers
- Neutral assemblies positioned opposite the mains compartment

**Mains**

- Factory-installed main lugs and main circuit breaker
- Multiple wire terminals for phases and neutral
- Top or bottom mains positioning

**Covers**

Flush and surface covers sold separately

**Enclosures**

- 20 in. (508 mm) wide galvanized steel
- Embossed 0.25 in. (6 mm) standoffs
- End walls, one blank and one with knockouts, are standard; both are removable and interchangeable
- Embossed keyholes centered at both ends and in visual positioning
- Multiple grounding bar mounting locations
- Wire management braces



QONQ30LS400  
(interior)



NC50NQVF



MH50

**Single-Phase – QO Load Centers, Special Purpose**



QO124L125PGC



QO24L60NRNM



QO1612M125FTRB



QO1DM10050TRBR



QO130L125PWG

**Special Purposes – Recreational vehicle and manufactured housing load centers**

- UL Listed (File E-6294)
- Single-phase, 2- and 3-wire
- Covers included with load centers

**Load centers with covers**

- Combination flush/surface cover included with load centers
- Equipment grounding bar included on main lug load centers
- Top or bottom feed on incoming service by rotating complete load center 180 degrees
- Convertible main load centers

**Non-metallic load center**

- UL Listed and suitable for use as service equipment
- Side-hinge door device
- 10,000 AIR rating
- Single-phase, 2- and 3-wire
- Factory-installed grounding bar
- Cover included with load center
- Knockouts in bottom endwall, side and back

**Generator panel manual transfer**

- Connects utility and standby power to installed branch circuits
- Includes two factory-installed two-pole main circuit breakers tied together with a mechanical interlock.
- 30 A and 60 A main circuit breaker versions
- Supply up to eight branch circuits using tandem circuit breakers
- Available indoor enclosure only
- Cover with door included

**Riser panels**

- Offset interior provides ample wire gutter space for high rise applications.
- Factory-installed main lugs (125 A), convertible to main circuit breaker with standard QOC cover and optional Mono-Flat cover.
- Factory-installed main lugs (200 A), convertible to main circuit breaker when used with QOC cover only.
- Indoor only, available in 12 to 40 circuits
- Optional Mono-Flat cover available for both 125 A and 200 A panels (sold separately).

## Fixed Mains vs. Convertible Mains – Three Phase

**Table 4 - Three-Phase — QO Load Centers, Fixed Mains (60–225 A)**

Indoor NEMA 1	Rainproof NEMA 3R
<b>Standards</b>	
UL Listed <ul style="list-style-type: none"> <li>• File E-6294</li> <li>• Suitable for use as service equipment</li> <li>• 75°C wire rating</li> </ul>	
<b>Short Circuit Current Rating</b>	
<ul style="list-style-type: none"> <li>• Main lugs: up to 65,000 AIR (depends on lowest interrupting rating of branch circuit breakers installed)</li> <li>• Main circuit breaker up to 100 A: 22,000 AIR standard</li> </ul>	
<b>Interior</b>	
<ul style="list-style-type: none"> <li>• Shielded, on-piece tin plated copper bus on 100–225 A</li> <li>• Removable interior with single, captive mounting screw on 100–225 A (indoor only)</li> <li>• Main lugs load centers have equipment grounding bar kits included (not factory-installed)</li> </ul>	
<b>Mains</b>	
<ul style="list-style-type: none"> <li>• Factory-installed main lugs</li> <li>• Main neutral terminal located next to the phase terminals on 125–225 A main circuit breaker devices</li> <li>• Top or bottom feed</li> </ul>	
<b>Covers</b>	
<ul style="list-style-type: none"> <li>• Flush and surface covers sold separately</li> <li>• Flush covers have spring-loaded interior trim for automatic flush adjustment</li> <li>• Easy to open door latch</li> </ul>	Cover included
<b>Branch Neutral Termination</b>	
<ul style="list-style-type: none"> <li>• Suitable for copper or aluminum wire</li> <li>• Terminals suitable for #14–#4 AWG copper or one #12–#4 AWG aluminum wire</li> <li>• Positioned on both sides of the mains compartment</li> <li>• Slot/square drive wire binding screws</li> <li>• Three (3) #14–1/0 AWG copper or #12–#6 AWG aluminum terminations standard on 12–42 circuits, 100–225 A load centers</li> </ul>	
<b>Main Circuit Breaker Kits</b>	
Not applicable	

**Table 5 - Three-Phase — QO Load Centers, Convertible Mains (100–225 A)**

Indoor NEMA 1		Rainproof NEMA 3R	
<b>Standards</b>			
UL Listed <ul style="list-style-type: none"> <li>• File E-6294</li> <li>• Suitable for use as service equipment</li> <li>• 75°C wire rating</li> </ul>			
<b>Short Circuit Current Rating</b>			
<ul style="list-style-type: none"> <li>• Main lugs: up to 65,000 AIR (depends on lowest interrupting rating of branch circuit breakers installed)</li> <li>• Main circuit breaker up to 100 A: 22,000 AIR standard</li> <li>• Main circuit breaker 125–225 A: 25,000 AIR standard; optional for field installation up to 65,000 AIR for 70–225 A main circuit breakers</li> </ul>			
<b>Interior</b>			
<ul style="list-style-type: none"> <li>• Shielded, one-piece tin plated copper bus on 100–225 A</li> <li>• Removable interior with single, captive mounting screw on 100–225 A (indoor only)</li> <li>• Main lugs load centers have equipment grounding bar kits included (not factory-installed)</li> </ul>			
<b>Mains</b>			
<ul style="list-style-type: none"> <li>• Factory-installed main circuit breaker</li> <li>• Main neutral terminal located next to the phase terminals on 125–225 A main circuit breaker devices</li> <li>• Top or bottom feed</li> <li>• Fully convertible from main circuit breaker to main lugs (100–225 A)</li> </ul>			
<b>Covers</b>			
<ul style="list-style-type: none"> <li>• Flush and surface covers sold separately</li> <li>• Flush covers have spring-loaded interior trim for automatic flush adjustment</li> <li>• Easy to open door latch</li> </ul>	Cover included		
<b>Branch Neutral Termination</b>			
<ul style="list-style-type: none"> <li>• Suitable for copper or aluminum wire</li> <li>• Terminals suitable for #14–#4 AWG copper or one #12–#4 AWG aluminum wire</li> <li>• Positioned on both sides of the mains compartment</li> <li>• Slot / square drive wire binding screws</li> <li>• Three (3) #14–1/0 AWG copper or #12–#6 AWG aluminum terminations standard on 12–42 circuits, 100–225 A load centers</li> </ul>			
<b>Main Circuit Breaker Kits</b>			
<ul style="list-style-type: none"> <li>• Field-installable in main circuit breaker load centers</li> <li>• 100–225 A main circuit breakers are series rated up to 100,000 AIR (see table below) with 10,000 AIR branch circuit breakers in 30 circuit or larger main circuit breaker load centers with optional QJL main circuit breaker</li> <li>• Electrical accessories are not available on QDL, QGL, or QJL circuit breakers</li> <li>• 30–42 circuit, 125–225 A main circuit breaker load centers include integral QDL circuit breakers. Optional QGL and QJL circuit breakers available as shown:</li> </ul>			
Amperage	25,000 AIR	65,000 AIR Main Circuit Breaker	100,000 AIR
70	QDL32070	QGL32070	QJL32070
80	QDL32080	QGL32080	QJL32080
90	QDL32090	QGL32090	QJL32090
100	QDL32100	QGL32100	QJL32100
110	QDL32110	QGL32110	QJL32110
125	QDL32125	QGL32125	QJL32125
150	QDL32150	QGL32150	QJL32150
175	QDL32175	QGL32175	QJL32175
200	QDL32200	QGL32200	QJL32200
225	QDL32225	QGL32225	QJL32225

(6) When these 3–pole circuit breakers are used as the main circuit breaker of a three-phase load center, the maximum AIR rating is 65,000 at 240 Vac and 100,000 at 208 Vac.

## QO Plug-on Neutral Load Centers

### Indoor, QO Convertible Mains (125–225 A), 1Ø – Main Lugs



QO120L125PG



QO130L200PG



QO154L225PG

**Table 6 - Plug-on Neutral Load Center Main Lugs, Convertible Mains (1Ø3W–120/240 Vac Indoor—UL Listed)**

Mains Rating	Spaces	Max. Single Pole Circuits	Max. Tandem Circuit Breakers	Load Center box and Interior	Load Center Covers (Order Separately)		Al	Cu	Equipment Ground Bar Kit (Factory-Included)	Box No.
					Flush/Surface	Mono-Flat				
<b>Convertible Mains — Factory-installed Main Circuit Breaker, 65 kA Short Circuit Current Rating — Copper Bus QOM1 Main Frame Size — Convertible to Main Circuit Breaker</b>										
125 A	12	24	12	QO112L125PH	QOC16UF <sup>(7)</sup> , QOC16US	—	6–2/0		PKGTALP1	6
	16	24	8	QO116L125PG	QOC24UF <sup>(7)</sup> , QOC24US	—				7
	20	24	4	QO120L125PG	QOC20U100F <sup>(7)</sup> , QOC20U100S	—				6
	24	34	10	QO124L125PG	QOC24UF <sup>(7)</sup> , QOC24US	—				7
	30	34	4	QO130L125PG	QOC30U125C	—				9
	32	38	6	QO132L125PG	QOC32UF <sup>(7)</sup>	—				8
<b>Convertible Mains — Factory-installed Main Circuit Breaker 65 kA Short Circuit Current Rating — Copper Bus QOM2 Main Frame Size — Convertible to Main Circuit Breaker</b>										
200 A	12	24	12	QO112L200PG	QOC30UF <sup>(7)</sup> , QOC30US	QOCMF30UC <sup>(9)</sup>	4–300	4–250	PKGTALP1	9
	24	36		QO124L200PG	QOC30UF <sup>(7)</sup> , QOC30US	QOCMF30UC <sup>(9)</sup>				
	30	40	10	QO130L200PG	QOC30UF <sup>(7)</sup> , QOC30US	QOCMF30UC <sup>(9)</sup>				
	40	60	20	QO140L200PG	QOC40UF <sup>(7)</sup> , QOC40US	—				
225 A	42	52	10	QO142L225PG	QOC42UF <sup>(7)</sup> , QOC42US	QOCMF42UC <sup>(9)</sup>	4–300		PKGTALP2	11
	54	72	18	QO154L225PG	QOC54UF <sup>(7)</sup>	QOCMF54UC <sup>(9)</sup>				12

(7) Maximum single pole branch circuits utilizing QO and/or QOT circuit breaker.

(8) See QO/Homeline Enclosure Dimensions and Knockout Information, page 67.

(9) Available in gray and white colors. For white equivalencies add the “W” suffix to the reference or see QO Load Center Covers, page 43.

## Indoor, QO Convertible Mains (100–225 A), 1Ø – Main Circuit Breaker



QO124M100P

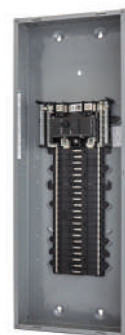

QO142M200P

**Table 7 - Plug-on Neutral Load Center Main Breaker, Convertible Mains (1Ø3W–120/240 Vac Indoor—UL Listed)**

Mains Rating	Spaces	Max. Single Pole Circuits	Max. Tandem Circuit Breakers	Load Center box and Interior	Load Center Covers (Order Separately)		Al	Cu	Equipment Ground Bar Kit (Factory-Included)	Box No.
					Flush/Surface	Mono-Flat				
<b>Convertible Mains — Factory-installed Main Lugs — 22 kA Short Circuit Current Rating</b>										
<b>Convertible to Main Lugs or Lower Amperage Main Circuit Breaker</b>										
100 A	12	24	12	QO112M100P	QOC12UF, QOC12US	—	6–2/0	6–1	PK9GTA	5
	16		8	QO116M100P	QOC20U100F <sup>(11)</sup> , QOC200U100S	—				6
	20		4	QO120M100P	QOC20U100F <sup>(11)</sup> , QOC200U100S	—				
	24	34	10	QO124M100P	QOC24UF <sup>(11)</sup> , QOC24US	—	6–2/0	PK15GTA	7	
	32	38	6	QO132M100P	QOC32UF <sup>(11)</sup>	—			8	
125 A	24	34	10	QO124M125P	QOC24UF <sup>(11)</sup> , QOC24US	—			PK15GTA	7
	32	38	6	QO132M125P	QOC32UF <sup>(11)</sup>	—				8
<b>Convertible Mains — Factory-Installed Main Lugs — 22 kA Short Circuit Current Rating</b>										
<b>Convertible to Main Lugs (see below ) or Lower Amperage Main Circuit Breaker</b>										
<b>QOM2 Main Circuit Breaker Frame Size — Copper Bus</b>										
150 A	20	30	10	QO120M150P	QOC30UF <sup>(11)</sup> , QOC30US	QOCMF30UC <sup>(11)</sup>	4–300	4–250	PK15GTA	9
	24	36	12	QO124M150P	QOC30UF <sup>(11)</sup> , QOC30US					
	30	40	10	QO130M150P	QOC30UF <sup>(11)</sup> , QOC30US					
	32	40	8	QO132M150P	QOC40UF <sup>(11)</sup> , QOC40US	—			PK18GTA	10

(10) See QO/Homeline Enclosure Dimensions and Knockout Information, page 67.

(11) Available in gray and white colors. For white equivalencies add the "W" suffix to the reference or see QO Load Center Covers, page 43.

**Table 7 - Plug-on Neutral Load Center Main Breaker, Convertible Mains(1Ø3W–120/240 Vac Indoor—UL Listed) (Continued)**

Mains Rating	Spaces	Max. Single Pole Circuits	Max. Tandem Circuit Breakers	Load Center box and Interior	Load Center Covers (Order Separately)		Al	Cu	Equipment Ground Bar Kit (Factory-Included)	Box No.
					Flush/Surface	Mono-Flat				
200 A	20	30	10	QO120M200P	QOC30UF <sup>(13)</sup> , QOC30US	QOCMF30UC <sup>(13)</sup>	4–300	4–250	PK15GTA	9
	24	36	12	QO124M200P	QOC30UF <sup>(13)</sup> , QOC30US					
	30	40	10	QO130M200P	QOC30UF <sup>(13)</sup> , QOC30US					
	40	60	20	QO140M200P	QOC40UF <sup>(13)</sup> , QOC40US	—	4–300	4–300	PK23GTA	10
	42	52	10	QO142M200P	QOC42UF <sup>(13)</sup> , QOC42US	QOCMF42UC <sup>(13)</sup>				11
	54	72	18	QO154M200P	QOC54UF <sup>(13)</sup>	QOCMF54UC <sup>(13)</sup>				12
	60	72	12	QO160M200PC <sup>(14)</sup>	QOC60UF/S Included	—	4–300	4–300	PK27GTA	24
225 A	40	60	20	QO140M225P	QOC42UF <sup>(13)</sup> , QOC42US	QOCMF42UC <sup>(13)</sup>	4–300	4–300	PK23GTA	11
	42	52	10	QO142M225P						

**NOTE:** 22 k AIR main circuit breaker UL Listed for use ahead of QO, QOT (20 A MAX. NON-CTL) and QO-PL 10 k AIR branch circuit breakers to permit their application on systems with up to 22 kA available fault current.

<sup>(12)</sup> See QO/Homeline Enclosure Dimensions and Knockout Information, page 67.

<sup>(13)</sup> Available in gray and white colors. For white equivalencies add the “W” suffix to the reference or see QO Load Center Covers, page 43.

<sup>(14)</sup> For Certification to IEC 60439–1 contact the local Square D sales office; otherwise panels are NOT CE marked. (For use on 415Y/240 Vac 3-phase 4-wire, 3,000 Short Circuit Current when QOXD... branch circuit breakers are used and 10,000 Short Circuit Current Rating when QO... VS branch circuit breakers are used).

## Indoor, QO Convertible Mains (125–225 A) with Qwik-Grip™, 1Ø



**Table 8 - QO Plug-On Neutral Load Centers with Qwik-Grip (1Ø3W-120/240 Vac Indoor—UL Listed)**

Mains Rating	Spaces	Max. Single Pole Circuits	Max. Tandem Circuit Breakers	Load Center box and Interior	Load Center Covers (Order Separately)		Al	Cu	Equipment Ground Bar Kit (Factory-Included)	Box No.
					Flush/Surface	Mono-Flat				
<b>Convertible Mains — Factory-Installed Main Lugs, 65 kA Short Circuit Current Rating — Copper Bus, QOM1 Main Frame Size, Convertible to Main Circuit Breaker</b>										
125 A	24	34	10	QO124L125PQG	QOC24UF <sup>(16)</sup> , QOC24US	—	6-2/0	PKGTALP1 Included		7Q
	30	34	4	QO130L125PQG	QOC30U125C	—				9Q
<b>Convertible Mains Factory — Installed Main Lugs, 65 kA Short Circuit Current Rating — Copper Bus, QOM2 Main Frame Size, Convertible to Main Circuit Breaker</b>										
200 A	30	40	10	QO130L200PQG	QOC30UF <sup>(16)</sup> , QOC30US	QOCMF30UC <sup>(16)</sup>	4-250	PKGTALP1 Included		9Q
225 A	42	52	10	QO142L225PQG	QOC42UF <sup>(16)</sup> , QOC42US	—	4-300	PKGTALP2 Included		11Q
	54	72	18	QO154L225PQG	QOC54UF <sup>(16)</sup>	QOCMF54UC <sup>(16)</sup>				12Q
<b>Convertible Mains-Factory — Installed main Lugs, 65 kA Short Circuit Current Rating — Copper Bus, QOM2 Main Frame Size, Convertible to Main Circuit Breaker</b>										
200 A	30	40	10	QO130M200PQ	QOC30UF <sup>(16)</sup> , QOC30US	QOCMF30UC <sup>(16)</sup>	4-250	PK18GTA (Order separately)		9Q
	42	52	10	QO142M200PQ	QOC42UF <sup>(16)</sup> , QOC42US	—	4-300	PK23GTA (Order separately)		11Q
	54	72	18	QO154M200PQ	QOC54UF <sup>(16)</sup>	QOCMF54UC <sup>(16)</sup>				12Q

(15) See QO/Homeline Enclosure Dimensions and Knockout Information, page 67.

(16) Available in gray and white colors. For white equivalencies add the "W" suffix to the reference or see QO Load Center Covers, page 43

## Indoor, QO Convertible Mains (125–225 A) with Included Cover 1Ø



**Table 9 - QO Load Centers with Included Cover (1Ø3W–120/240 Vac Indoor—UL Listed)**

Mains Rating	Short Circuit Current Rating	Spaces	Max. Single Pole Circuits	Max. Tandem Circuit Breakers	Load Center Box, Interior, and Cover	Al	Cu	Equipment Ground Bar Kit (Order Separately)	Box No.
125 A	65 kA	12	24	12	QO112L125PGC	6–2/0		PKGTALP1 Included	6
		20		4	QO120L125PGC				7
		24	10	QO124L125PGC					
<b>Convertible Mains — Factory-Installed Main Lugs <sup>(18)</sup></b>									
200 A	65 kA	30	40	10	QO130L200PGC	4–300		PKGTALP1 Included	9
225 A		42	52	10	QO142L225PGC				11
		54	72	18	QO154L225PGC				12
<b>Convertible Mains — Factory-Installed Main Circuit Breaker — QOM1 Main Frame Size — Convertible to Main Lugs <sup>(19)</sup></b>									
100 A	22 kA	12	24	12	QO112M100PC	6–2/0	6–1	PK9GTA	5
		16		8	QO116M100PC				6
		20		4	QO120M100PC				
		24	34	10	QO124M100PC	6–2/0	PK15GTA, LK100AN	7	
<b>Convertible Mains — Factory-Installed Main Circuit Breaker — QOM2 Main Frame Size — 10 Convertible to Main Lug <sup>(19)</sup></b>									
150 A	22 kA	30	40	10	QO130M150PC	4–300	4–250	PK18GTA, LK100AN, PK23GTA, LK100AN	9
		42	52		QO142M150PC	4–300		PK18GTA, LK100AN	11
200 A	22 kA	30	40	10	QO130M200PC	4–300	4–250	PK23GTA	9
		40	60	20	QO140M200PC				10
		42	52	10	QO142M200PC	4–300	PK23GTA, LK100AN	11	
		54	72	18	QO154M200PC			12	

(17) Maximum single pole branch circuits utilizing QO and/or QOT (20 A MAX. NON-CTL) circuit breakers.  
 (18) UL Listed 5000 A short circuit current rating for corner grounded Delta systems (Use QO-H circuit breakers only).  
 (19) 22 k AIR main circuit breaker UL Listed for use ahead of QO, QOT and QO-PL 10 k AIR branch circuit breakers to permit their application on systems with up to 22 kA available fault current.

## Rainproof, QO Convertible Mains (100–225 A), 1Ø – Main Lugs and Main Breaker

**Table 10 - Plug-on Neutral Load Center Main Lugs, Convertible Mains (1Ø3W–120/240 Vac Rainproof – UL Listed)**

Mains Rating	Spaces	Max. Single Pole Circuits	Max. Tandem Circuit Breakers	Load Center box and Interior	Al	Cu	Equipment Ground Bar Kit (Factory-Included)	Box No.
<b>Convertible Mains — Factory-Installed Main Lugs – 65 kA Short Circuit Current Rating <sup>(22), (23), (24)</sup> QOM1 Main Circuit Breaker Frame Size, Convertible to Main Circuit Breaker – Equipment Ground Bar Included</b>								
125 A	12	24	12	QO112L125PGRB	6–2/0		PKG TALP1	3R
	16		8	QO116L125PGRB				4R
	24	34	10	QO124L125PGRB				
<b>Convertible Mains — Factory-Installed Main Lugs – 65 kA Short Circuit Current Rating <sup>(23), (24)</sup> QOM2 Main Circuit Breaker Frame Size, Convertible to Main Circuit Breaker – Equipment Ground Bar Included</b>								
200 A	12	24	12	QO112L200PGRB	4–300	4–250	PKG TALP1	5R
	30	40	10	QO130L200PGRB				6R
	40	60	20	QO140L200PGRB			PKG TAL2	7R
225 A	42	52	10	QO142L225PGRB	4–300		PKG TALP2	8R

**Table 11 - Plug-on Neutral Load Center Main Breaker, Convertible Mains (1Ø3W–120/240 Vac Rainproof – UL Listed)**

Mains Rating	Spaces	Max. Single Pole Circuits	Max. Tandem Circuit Breakers	Load Center Box and Interior	Al	Cu	Equipment Ground Bar Kit (Order Separately)	Box No.			
<b>Convertible Mains – Factory-Installed Main Lugs – 22 kA Short Circuit Current Rating Convertible to Main Lugs <sup>(25)</sup> QOM1 Main Circuit Breaker Frame Size – Copper Bus</b>											
100 A	12	24	12	QO112M100PRB	6–2/0		PK9GTA	3R			
	16		8	QO116M100PRB				4R			
	20		4	QO120M100PRB							
	24	34	10	QO124M100PRB			PK15GTA	4R			
125 A	24	34	10	QO124M125PRB							
<b>Convertible Mains – Factory-Installed Main Lugs – 22 kA Short Circuit Rating Convertible to Main Lugs <sup>(26)</sup> QOM2 Main Circuit Breaker Frame Size – Copper Bus</b>											
150 A	20	30	10	QO120M150PRB	4–300	4–250	PK15GTA	5R			
	30	40		QO130M150PRB				6R			
200 A	20	30	10	QO120M200PRB				4–300	4–250	PK23GTA	5R
	30	40		QO130M200PRB							6R
	40	60	20	QO140M200PRB	7R						
	42	52	10	QO142M200PRB	4–300		PK18GTA	8R			
225 A	42	52	10	QO142M225PRB	4–300						

(20) Maximum single pole branch circuits utilizing QO and/or QOT circuit breakers.  
 (21) See QO/Homeline Enclosure Dimensions and Knockout Information, page 67.  
 (22) UL Listed 5000 A short circuit current rating for corner grounded Delta systems. Use QO-H circuit breakers only.  
 (23) UL short circuit current rating depends on lowest interrupting rating of circuit breaker installed.  
 (24) Side hinge door device; allow 1–1/4 in. on left side for door to open.  
 (25) 22 k AIR main circuit breaker UL Listed for use ahead of QO, QOT, QO-GFI, QO-AFI, QO-EPD and QOPL 10 k AIR branch circuit breakers to permit their application on systems up to 22 kA.  
 (26) 22 k AIR main circuit breaker UL Listed for use ahead of QO, QOT, QO-GFI, QO-AFI, QO-EPD and QOPL 10k AIR branch circuit breakers to permit their application on systems up to 22 kA.

## Backup Power Solutions, (30–200 A), 1Ø



**Table 12 - Backup Power Solutions (1Ø3W–120/240 Vac Backup Power — UL Listed)**

Mains Rating	Spaces	Max. Single Pole Circuits	Max. Tandem Circuit Breakers	Load Center Box and Interior	Equipment Ground Bar Kit (Order Separately)	Al	Cu	Box No.
<b>Generator Panels — Manual Transfer for Sub-Feed Applications NEMA 1 (Indoor)</b> Factory-Installed Main Circuit Breakers with Mechanical Interlock — 10 kA Short Circuit Current Rating								
30 A	4	8	4	QO48M30DSGP	PK7GTA	8–1		4
60 A				QO48M60DSGP				
<b>Generator Panels — Manual Transfer with Generator Power Inlet Plug for Sub-Feed Application NEMA 3R (Outdoor)</b> Factory-Installed Main Circuit Breakers with Mechanical Interlock — 10 kA Short Circuit Current Rating								
100 A	4	8	4	QO1DM10020TRBR	Factory-Installed	—	8–2	17R
				QO1DM10030TRBR				
				QO1DM10050TRBR				

## QO Riser Panels (125–200 A), 1Ø

**Table 13 - QO Riser Panels (1Ø3W–120/240 Vac Special Applications — UL Listed)**

Mains Rating	Spaces	Max. 1P Circuits	Max. Tandem Circuit Breakers	Load Center Box and Interior	Indoor Cover		Equipment Ground Bar Kit (Order Separately)	Main Wire Size AWG/kcmil		Box No.
					Flush	Mono-Flat		Al	Cu	
<b>Convertible Mains — Factory-Installed Main Lugs, 65 kA Short Circuit Current Rating Convertible to QOM1 22 kA Short Circuit Current Rating Main Circuit Breaker when used with QOC cover below — Copper Bus</b>										
125 A	12	24	12	QO112L125PWG	QOC20UFWG <sup>(30)</sup>	NQC20FWG <sup>(30)</sup>	PK15GTA	6–2/0		14
	20		4	QO120L125PWG						
<b>Convertible Mains — Factory-Installed Main Lugs, 65 kA Short Circuit Current Rating Convertible to QOM2 22 kA Short Circuit Current Rating Main Circuit Breaker (See Indoor, QO Convertible Mains (125–225 A), 1Ø – Main Lugs, page 19) when used with QOC cover below — Copper Bus</b>										
200 A	30	40	10	QO130L200PWG	QOC30UFWG <sup>(30)</sup>	NQC30FWG <sup>(30)</sup>	PK23GTA	4–300	4–250	23

(27) Maximum single pole branch circuits utilizing QO and/or QOT (20 A MAX. NON-CTL.) circuit breakers.

(28) See QO/Homeline Enclosure Dimensions and Knockout Information, page 67.

(29) Maximum single pole branch circuits utilizing QO and/or QOT circuit breakers.

(30) Available in gray and white colors. For white equivalencies add the “W” suffix to the reference or see QO Load Center Covers, page 43.

**Table 13 - QO Riser Panels (1Ø3W–120/240 Vac Special Applications — UL Listed (Continued))**

Mains Rating	Spaces	Max. 1P Circuits	Max. Tandem Circuit Breakers	Load Center Box and Interior	Indoor Cover		Equipment Ground Bar Kit (Order Separately)	Main Wire Size AWG/kcmil		Box No.
					Flush	Mono-Flat		Al	Cu	
<b>Convertible Mains — Factory-Installed Main Circuit Breaker, 22 kA Short Circuit Current Rating Convertible to Main Lugs (See Indoor, QO Convertible Mains (125–225 A), 1Ø – Main Lugs, page 19) or Lower Amperage QOM2 Main Circuit Breaker (See Indoor, QO Convertible Mains (100–225 A), 1Ø – Main Circuit Breaker, page 20) when used with QOC cover below — Copper Bus</b>										
200 A	24	36	12	QO124M200PWF125 <sup>(33)</sup>	QOC30UFWG <sup>(34)</sup>	NQC30FWG <sup>(34)</sup>	PK23GTA	4–300	4–250	23

**Panelboard-style Covers for Riser Panels**

Mono-Flat™ Front available for riser panels as an alternative standard load center cover listed above. Provides a low-profile, aesthetically pleasing solution for high-traffic areas in upscale multi-family applications. Deadfront included. Lock kit not provided. Cover NQC30FWG CANNOT be used when panel has been converted to a main circuit breaker panel. <sup>(35)</sup>

Mains Rating of Load Center	Cat. No.
125 A	NQC20FWG
200 A	NQC30FWG

**Table 14 - Auxiliary Gutter**

Cat. No.	Cover	Conduit Riser Size	Width	Height	Depth
UL Listed for use with standard 1Ø and 3Ø load centers for riser applications <sup>(36)</sup> .					
SDAG26	Flush	1–3/4, 2, 2–1/2 <sup>(37)</sup> or 3	13.5	26.12	3.75

**Table 15 - Tap Kits for Use with Auxiliary Gutter**

Cat. No.	Use with Auxiliary Gutter Cat. No.	Riser Wire		Tap Off Wire	
		Lug Type	Al/Cu Wire Size	Lug Type	Al/Cu Wire Size
SDGT30020	SDAG26	Mechanical (Included)	(2) 6 AWG-300 kcmil	Mechanical (Included)	(1) 6–2/0 AWG
SDGT300300					(2) 6 AWG-300 kcmil
SDGT300C10C		Anderson VCEL030516H1 (Not Included)	(2) 4 AWG-300 kcmil	Anderson VCEL02114S1 (Not Included)	(1) 8–1/0 AWG
SDGT300C300C				Anderson VCEL030516H1 (Not Included)	(2) 4 AWG-300 kcmil
QOGL20 Grounding Terminals		Mechanical (Included)	(2) 6–2/0 AWGI	—	—

<sup>(31)</sup> Maximum single pole branch circuits utilizing QO and/or QOT circuit breakers.

<sup>(32)</sup> See QO/Homeline Enclosure Dimensions and Knockout Information, page 67.

<sup>(33)</sup> Comes with 125 A main circuit breaker factory installed.

<sup>(34)</sup> Available in gray and white colors. For white equivalencies add the “W” suffix to the reference or see QO Load Center Covers, page 43.

<sup>(35)</sup> Order catalog number PK4FL for field-installed lock kit.

<sup>(36)</sup> One tap kit required for each riser wire.

<sup>(37)</sup> When used with B300 bolt-on hubs.

## QO Standard Load Centers

### Indoor, QO Fixed Mains (30–125 A), 1Ø – Main Lugs and Main Breaker

QO Standard Load Center Main Lugs and Main Breaker, Fixed Mains  
(1Ø3W–120/240 Vac Special Applications – UL Listed)

**Table 16 - Low Amperage Fixed Main Lugs Indoor Load Centers (accepts only QO Plug-on Circuit Breakers – not compatible with QO Plug-on Neutral Circuit Breakers)**

Mains Rating	Spaces	Max. 1P Circuit	Max. Tandem Circuit Breakers	Load Center Box and Interior	Indoor Cover with Door		Main Wire Size AWG/kcmil		Equipment Ground Bar Kit (Order Separately)	Box No.
					Flush	Surface	Al	Cu		
<b>Fixed mains – Factory-Installed Main Lugs – 10 kA Short Circuit Current Rating <sup>(39)</sup></b>										
30 A	2	2	0	QO20L30S <sup>(40), (41)</sup>	Cover Included — Without Door		12–10	14–10	PK3GTA1	1
70 A		4	2	QO24L70F/S <sup>(42), (43)</sup>			12–10	14–10	PK4GTA	2
100 A	6	12	6	QO612L100F/S <sup>(42), (44)</sup>	Cover Included — With Door		8–1/0	PK7GTA	4	
				QO612L100DF/S <sup>(42), (44)</sup>						
	8	16	8	QO816L100F/S <sup>(42), (44)</sup>	Cover Included — Without Door					
				QO816LL100DF/S <sup>(42), (44)</sup>						
	6	12	6	QO612L100DFCU/SCU <sup>(42), (44), (45)</sup>	Cover Included — With Door					
QO816L100DFCU/SCU <sup>(42), (44), (45)</sup>										
125 A	4	8	4	QO148L125GF/S <sup>(42), (46)</sup>	Cover Included — Without Door		12–10	14–2/0	PK7GTA <sup>(47)</sup>	21

**Table 17 - Low Amperage Fixed Mains Indoor Load Centers with Factory Installed Ground Bar (Accepts only QO Plug-On Circuit Breaker – not compatible with QO Plug-on Neutral Circuit Breakers)**

Mains Rating	Short Circuit Current Rating	Spaces	Max. 1P Circuits	Max. Tandem Circuit Breakers	Load Center, Box, Interior, and Cover	Equipment Ground Bar Kit (Order Separately)	Main Wire Size AWG/kcmil		Box No.
							Al	Cu	
<b>Manufactured Hourings: 1Ø2W 120 Vac — Main Lugs Only — CSA Certified</b>									
30 A <sup>(41)</sup>	10 kA	2	2	0	QO2L30TTS <sup>(40)</sup>	Factory-Installed	12–10	14–10	1
50 A			4	2	QO24L50TTS <sup>(43)</sup>		—	14–6	2
<b>1Ø2W 120 Vac — Main Circuit Breaker — CSA Certified</b>									
30 A	10 kA	3	5	2	QO35FM30TTF/S	Factory-Installed	<sup>(48)</sup>		3
<b>1Ø2W 120 Vac — Main Circuit Breaker — CSA Certified</b>									
70 A	10 kA	2	4	2	QO24L70TS <sup>(43)</sup>	Factory-Installed	12–3	14–4	2

<sup>(38)</sup> Maximum single pole branch circuits utilizing QO and/or QOT circuit breaker.  
<sup>(39)</sup> UL short circuit current rating depends on lowest interrupting rating of circuit breaker installed.  
<sup>(40)</sup> Will not accept QO-EPD or Qwik-Gard QO-GFI or QO-AFI circuit breakers.  
<sup>(41)</sup> Mains rated 25 A when Al wire is used.  
<sup>(42)</sup> Order F for flush device or S for surface device.  
<sup>(43)</sup> Use 10 AWG maximum size wire for GFI and AFI circuit breakers.  
<sup>(44)</sup> 70 A Max. branch circuit breaker and 100 A max. back fed main circuit breaker.  
<sup>(45)</sup> CU indicates copper bus.  
<sup>(46)</sup> Copper bus.  
<sup>(47)</sup> Factory-included  
<sup>(48)</sup> Main circuit breaker is field-installed standard QO single pole circuit breaker.

## Indoor, QO Fixed Mains (300–400 A), 1Ø – Main Lugs and Main Breaker

QO Standard Load Center Main Lugs and Main Breaker, Fixed Mains  
(1Ø3W–120/240 Vac Special Applications – UL Listed)



**Table 18 - High Amperage Fixed Main Breaker and main Lugs Indoor Load Centers (Accepts Only QO Plug-On Circuit Breakers – Not compatible with QO Plug-on Neutral Circuit Breakers)**

Mains Rating	Spaces	Max. 1P Circuits	Max. Tandem Circuit Breakers	Load Center Box and Interior	Indoor Cover with Door (Order Separately)		Main Wire Size AWG/kcmil		Equipment Ground Bar Kit (Order Separately)	Box No.
					Flush	Surface	Al	Cu		
<b>Fixed Mains – Factory-Installed Main Circuit Breaker – 65 kA Short Circuit Current Rating</b>										
300 A	42	42	0	QONQ42MS300 (Int) <sup>(49)</sup> MH62 (Box) <sup>(50)</sup>	NC62NQVF	NC62NQVS	(1) 4–500 or (2) 4–3/0	PK27GTA <sup>(51)</sup> or PK15GTA6	16	
400 A				QONQ42MS400 (Int) <sup>(49)</sup> MH62 (Box) <sup>(50)</sup>						
<b>Fixed Mains – Factory-Installed Main Lugs – 65 kA Short Circuit Current Rating <sup>(52), (53)</sup></b>										
400 A	30	30	0	QONQ30LS400 (Int) <sup>(49)</sup> MH50 (Box) <sup>(50)</sup>	NC50NQVF	NC50NQVS	(1) 1/0–750 or (2) 1/0–300	PK27GTA <sup>(51)</sup> or PK15GTA6	15	
	42	42		QONQ42LS400 (Int) <sup>(49)</sup> MH50 (Box) <sup>(50)</sup>						

<sup>(49)</sup> Interior only, order box separately.

<sup>(50)</sup> PE1A Discount Schedule.

<sup>(51)</sup> PK27GTA includes a 6–2/0 AWG Al/Cu lug.

<sup>(52)</sup> UL short circuit current rating depends on lowest interrupting rating of circuit breaker installed.

<sup>(53)</sup> UL Listed 5000 A short circuit current rating for corner grounded Delta systems. Use QO-H circuit breakers only.

## Rainproof, QO Fixed and Convert. Mains (60–200 A), 1Ø – Main Lugs and Main Breaker



QO24L60NRNM



QO816L100RB

**Table 19 - QO Standard Load Center Main Lugs, Fixed Mains (1Ø3W–120/240 Vac Rainproof — UI Listed**

Mains Rating	Spaces	Max. Single Pole Circuits	Max. tandem Circuit Breakers	Load Center Box and Interior	Main Wire Size AWG / kcmil		Equipment Ground Bar Kit (Order Separately)	Box No.
					Al	Cu		
<b>Non-Metallic Enclosure</b>								
<b>Fixed Mains — Factory-Installed Main Lugs — 10 kA Short Circuit Current Rating</b>								
60 A	2	4	2	QO24L60NRNM	12–4	14–4	Factory-Installed	1NM
<b>Metallic Enclosure</b>								
<b>Fixed Mains — Factory-Installed Main Lugs — 10 kA Short Circuit Current Rating</b>								
40 A	2	2	0	QO2L40RB (55)	12–6	14–6	PK3GTA1	1R
70 A		4	2	QO24L70RB (55)	12–3	14–4	PK4GTA	
100 A	6	12	6	QO612L100RB (56)	8–1/0		PK7GTA	2R
				QO612L100TRB (56)			Factory-installed	
	8	16	8	QO816L100RB (56)			PK7GTA	
	6	12	6	QO612L100RBCU (56), (57)				
	8	16	8	QO816L100RBCU (56), (57)				
125 A	4	8	4	QO148L125GRB (57)	12–2/0	14–2/0	PK7GTA Factory-Included	15R

**Table 20 - QO Standard Load Center Main Breaker, Convertible Mains (1Ø3W–120/240 Vac Rainproof — UL Listed**

Mains Rating	Spaces	Max. Single Pole Circuits	Max. tandem Circuit Breakers	Load Center Box and Interior	Main Wire Size AWG / kcmil		Equipment Ground Bar Kit (Order Separately)	Box No.
					Al	Cu		
<b>Convertible Mains — Factory-Installed Main Circuit Breaker with Feed-thru Lugs, 22 kA Short Circuit Current Rating</b>								
<b>Convertible to Main Lugs or Lower Amperage Main Circuit Breaker (59), (60) QOM1 or QOM2 Main Circuit Breaker Frame Size — Copper Bus</b>								
125 A	6	12	6	QO1612M125FTRB (61)	4–2/0		PK12GTA	3R
150 A	8	16	8		4–250		PK15GTAL	4R
200 A	8	16	8	QO1816M200FTRB (61)				

(54) Maximum single pole branch circuits utilizing QO and/or QOT circuit breakers.  
 (55) Use 10 AWG maximum size wire for GFI and AFI circuit breaker.  
 (56) 70 A Max. branch circuit breaker and 70 A max. back fed main circuit breaker.  
 (57) Copper bus.  
 (58) See QO/Homeline Enclosure Dimensions and Knockout Information, page 67.  
 (59) Side hinge door device; allow 1–1/4 in. on left side for door to open.  
 (60) 22 k AIR main circuit breaker UL Listed for use ahead of QO, QOT, QO-GFI, QO-AFI, QO-EPD and QOPL 10 k AIR branch circuit breakers to permit their application on systems up to 22 kA  
 (61) QO1612M125FTRB provided with QOM1 frame main circuit breaker. QO1816M150FTRB and QO1816M200FTRB provided with QOM2 frame main circuit breaker.

## Indoor and Rainproof, QO Fixed and Convertible Mains (60–225 A), 3Ø – Main Lugs and Main Breaker

**Table 21 - QO Standard Load Center Main Lugs and Main Breaker (3Ø4W–208Y/120 Vac, 3Ø4W–240/120 Vac Delta, and 3Ø3W–240 Vac Delta–Indoor and Rainproof–UL Listed)**

Mains Rating	Max. Number of 1P QO circuit breakers	Load Center Box and Interior	Indoor Cover with Door (Order Separately)		Main Wire Size AQG / kcmil		Equipment Ground Bar Kit (Order Separately)	Box No.
		Cat. No.	Flush	Surface	Al	Cu		
<b>Fixed Mains – Factory-Installed Main Lugs – Copper Bus – 65 kA Short Circuit Current Rating <sup>(63)</sup></b>								
60 A	3	QO403L60NF/S	Cover Included With Load Center (No Door)		12–6	14–6	PK4GTA	13
125 A	12	QO312L125G <sup>(64)</sup>	QOC16UF	QOC16US	6–2/0	6–2/0	Factory-Included <sup>(65)</sup>	6
	20	QO320L125G <sup>(64)</sup>	QOC24UF	QOC24US				7
	24	QO324L125G <sup>(64)</sup>	QOC24UF	QOC24US				
200 A	18	QO318L200G <sup>(64)</sup>	QOC30UF	QOC30US	4–250	4–250		9
	30	QO330L200G <sup>(64)</sup>	QOC30UF	QOC30US				
225 A	42	QO342L225G <sup>(64)</sup>	QOC42UF	QOC42US	4–300	4–300		11
<b>Convertible Mains – Factory-Installed QDL Main Circuit Breaker – Copper Bus – 25 kA Short Circuit Current Rating <sup>(66)</sup></b>								
100 A	27	QO327M100 <sup>(67)</sup>	QOC30UF	QOC30US	6–1	6–1	PK15GTA	9
125 A	30	QO330MQ125 <sup>(68), (69)</sup>	QOC342MQF	QOC342MQS	4–250	4–250	PK18GTA	12
150 A	30	QO330MQ150 <sup>(68), (69)</sup>	QOC342MQF	QOC342MQS				PK23GTA
	42	QO342MQ150 <sup>(68), (69)</sup>	QOC342MQF	QOC342MQS				
200 A	30	QO330MQ200 <sup>(68), (69)</sup>	QOC342MQF	QOC342MQS				
	42	QO34MQ200 <sup>(68), (69)</sup>	QOC342MQF	QOC342MQS				
225 A	42	QO342MQ225 <sup>(68), (69)</sup>	QOC342MQF	QOC342MQS				

<sup>(62)</sup> See QO/Homeline Enclosure Dimensions and Knockout Information, page 67.

<sup>(63)</sup> UL short circuit current rating depends on lowest interrupting of circuit breaker installed.

<sup>(64)</sup> For Certification to IEC 60439–1 contact the local Square D sales office; otherwise panels are NOT CE marked. (For use on 415Y/240 Vac 3-phase 4-wire, 3,000 Short Circuit Current Rating when QOXD branch circuit breakers are used and 10,000 Short Circuit Current Rating when QO vs. branch circuit breakers are used).

<sup>(65)</sup> PKGTALP1

<sup>(66)</sup> 25 kA short circuit current rating SCCR maximum with Square D Type QDL main circuit breaker, or 22 kA SCCR maximum with back-fed Type QO-VH main circuit breaker, feeding QO 10 k AIR branch circuit.

<sup>(67)</sup> Includes factory-installed back fed QO3100VH main circuit breaker.

<sup>(68)</sup> 65 kA Short Circuit Current Rating maximum with field-installed Square D type QGL 65 k AIR minimum main circuit breaker feeding QO and Q1 10 k AIR minimum branch circuit breakers.

<sup>(69)</sup> For Certification to IEC 60439–1 contact the local Square D sales office; otherwise panels are NOT CE marked. (For use on 415Y/240 Vac 3-phase 4-wire, 3,000 Short Circuit Current Rating when QOXD... branch circuit breakers are used and 10,000 Short Circuit Current Rating when QO...VS branch circuit breakers are used).

**Table 21 - QO Standard Load Center Main Lugs and Main Breaker (3Ø4W–208Y/120 Vac, 3Ø4W–240/120 Vac Delta, and 3Ø3W–240 Vac Delta–Indoor and Rainproof–UL Listed) (Continued)**

	Mains Rating	Max. Number of 1P QO circuit breakers	Load Center Box and Interior Cat. No.	Indoor Cover with Door (Order Separately)		Main Wire Size AQQ / kcmil		Equipment Ground Bar Kit (Order Separately)	Box No.
				Flush	Surface	Al	Cu		
Rainproof	<b>Fixed Mains – Factory-Installed Main Lugs – Copper Bus – 65 kA Short Circuit Current Rating <sup>(71), (72)</sup></b>								
	60 A	3	QO403L60NRB	Cover Included		12–6	14–6	PK4GTA	10R
	125 A	12	QO312L125GRB			6–2/0	6–2/0	Factory-Included <sup>(73)</sup>	3R
		20	QO320L125GRB			4R			
	200 A	18	QO318L200GRB			4–250	4–250	Factory-Included <sup>(74)</sup>	6R
		30	QO330L200GRB			8R			
	225 A	42	QO342L225GRB			4–300	4–300		
	<b>Convertible Mains – Factory-Installed QDL Main Circuit Breaker – Copper Bus – 25 kA Short Circuit Current Rating <sup>(75), (72)</sup></b>								
	100 A	27	QO327M100RB <sup>(76)</sup>	Cover Included		4–2/0	4–2/0	PK15GTA	6R
	125 A	30	QO330MQ125RB <sup>(77)</sup>					4–250	4–250
	150 A		QO330MQ150RB <sup>(77)</sup>						
	200 A		QO330MQ200RB <sup>(77)</sup>						
	225 A	42	QO342MQ200RB <sup>(77)</sup>					PK23GTA	
			QO342MQ225RB <sup>(77)</sup>						

(70) See QO/Homeline Enclosure Dimensions and Knockout Information, page 67.  
 (71) UL short circuit current rating depends on lowest interrupting rating of circuit breaker installed.  
 (72) Side hinge door device allow 1–1/4 in. on left side for door to open.  
 (73) PKGTALP1  
 (74) PKGTALP2  
 (75) 25 kA short circuit current rating SSCR maximum with Square D Type QDL main circuit breaker, or 22 kA SCCR maximum with back-fed Type QO-VH main circuit breaker feeding QO 19 k AIR branch circuit.  
 (76) Includes factory-installed back fed QO3100VH main circuit breaker.  
 (77) 65 kA Short Circuit Current Rating maximum with field-installed Square D type QGL 65 k AIR minimum main circuit breaker feeding QO and Q1 10 k AIR minimum branch circuit breakers.

## Mains Kits, 1Ø and 3Ø

**Table 22 - 1Ø, Field-Installed Main Circuit Breaker Kits**



QOM2100VH

Main Circuit Breaker Rating	Convertible Load Center Mains Rating	22 k AIR	Lug Wire Size AWG/kcmil	
		Main Circuit Breaker		
<b>QOM1 Frame Size — Use with Convertible Main Load Centers Only</b>				
50 A	100–125	QOM50VH	12–2/0 Al or Cu	
60 A		QOM60VH		
70 A		QOM70VH		
80 A		QOM80VH		
90 A		QOM90VH		
100 A		QOM100VH		
110 A	125	QOM110VH		
125 A		QOM125VH		
<b>QOM2 Frame Size — Use with Convertible Main Load Centers Only</b>				
100 A	150–225	QOM2100VH		4–300 Al or Cu
125 A		QOM2125VH		
150 A		QOM2150VH		
175 A	200–225	QOM2175VH		
200 A		QOM2200VH		
225 A		QOM2225VH		

**Table 23 - 1Ø, Field-Installed Main Lugs Kits**



QOL125

Main Lugs Rating	Use on Convertible Load Center with Mains Rating	Cat. No.	Lug Wire Size AWG/kcmil Al or Cu
125 A	100–125 A	QOL125 <sup>(82)</sup>	6–2/0
		QOL125VD <sup>(82)</sup>	6–4/0
225 A	150–225 A	QOL225 <sup>(82)</sup>	6–300



QGL32080

- (78) Do not exceed the load center mains rating.
- (79) 22 k AIR main circuit breaker UL Listed for use ahead of QO, QOT and QO-PL 10 k AIR branch circuit breakers to permit their application on systems with up to 22 kA available fault current.
- (80) Wire range listed for QOL lug kits is the wire range of that lug. To find out maximum wire size permitted in a particular load center per UL, see Main Wire Size in that load center table.
- (81) Add suffix 1021 for 120, 208, or 240 Vac shunt trip.
- (82) If main circuit breaker knockout has been removed from the load center's trim, order appropriate filler plate from Table 1.51, page 1–24.

Table 24 - 3Ø, Main Circuit Breakers

Amperage	25 k AIR	65 k AIR	100 k AIR
<b>Field-Installed Alternate Main Circuit Breakers for QO 3Ø Main Circuit Breaker Load Centers rated 70–225 A. Do not exceed the load center main rating.</b>			
70 A	QDL32070	QGL32070	QJL32070
80 A	QDL32080	QGL32080	QJL32080
90 A	QDL32090	QGL32090	QJL32090
100 A	QDL32100	QGL32100	QJL32100
110 A	QDL32110	QGL32110	QJL32110
125 A	QDL32125	QGL32125	QJL32125
150 A	QDL32150	QGL32150	QJL32150
175 A	QDL32175	QGL32175	QJL32175
200 A	QDL32200	QGL32200	QJL32200
225 A	QDL32225	QGL32225	QJL32225

Table 25 - 3Ø, Main Lugs Kits

Main Lugs Amperage Rating	Cat. No.	Lug Wire Size AWG/kcmil
<b>Field-Installed Main Lugs for Convertible 3Ø Main Circuit Breaker Load Centers</b>		
125 A	QOL3125	6–2/0 Cu/Al
225 A	QOL3225	6–300 Cu/Al

## QO Label Samples

## QO Box Label Sample

<ul style="list-style-type: none"> <li>Number of circuits maximum</li> <li>Enclosure catalog number</li> <li>Catalog number of covers; flush or surface</li> <li>See load center interior for the catalog number</li> <li>Voltage ratings</li> <li>Amperage rating</li> </ul>	<p>Wire range for lug torque data rating</p>	<p>Short circuit ratings</p>	<p>Short circuit ratings and additional or replacement circuit breakers</p>	<ul style="list-style-type: none"> <li>UL manifest</li> <li>CE if required</li> <li>NOM if required</li> <li>Date code</li> <li>Plant code</li> <li>Label part number</li> <li>Manufacturer trademark</li> </ul>
---	--	------------------------------	---	--

**QO™ LOAD CENTER**  
See panelboard interior for Catalog No. Box / Caja: BX339  
Cover / Cubierta: QOC342MCF or/ó QOC342MCS  
Circuit max. / Max. Circuitos: 42  
Type 1 (IP20) Enclosure / Gabinete Tipo 1  
Use 415V/240 V~, 3Ø - 4 wire/whicos (IEC), UL 2,000 volts 50 / 60 Hz (IEC). For 240V~ - 3 Ph-3 W system, use only breakers rated 240 V. For 240/120 V~ - 3Ph - 4W delta systems, "B" phase must be 200V~ neutral. Breaker poles connected to phase "B" must be rated 240 V~.  
Main max. / Max. Linea principal :225A  
See main or service disconnect rating if installed.  
240 V~ Max., 3Ø, 50/60 Hz, (UL)

**LUG TORQUE DATA**  
SEE CIRCUIT BREAKERS AND FIELD INSTALLED UNITS FOR WIRE RANGE AND TORQUE.

Lug type	Wire Range (AWG/kcmil)	Torque (Inch)
Line Neutral Lug	# 250 Cu/Al	250
Main Lug	# 250 Cu/Al	250
Alternate Main Breaker	See Main Breaker	Breaker

**BRANCH NEUTRAL & EQUIPMENT GROUNDING BAR**

WIRE RANGE (AWG)	TORQUE (Lb-in)		BAR WITH 1 SCREW SIZE
	BAR WITH 3 SCREWS	SMALL	
1Ø - 3 Cu/Al	50	—	—
4 Cu/Al	45	—	3/8
Ø Cu/Al	45	25	3/8
Ø Cu/Al	40	10	25
1Ø-14 Cu, 1Ø-37 Al	—	10	20

**EQUIPMENT GROUND COMBINATIONS**

(1) 14 Cu	25	30	25
(2) 12 Cu/Al	25 <td>30 <td>25</td> </td>	30 <td>25</td>	25
(3) 10 Al	25	—	25

**SHORT CIRCUIT CURRENT RATING**

RMS Symmetrical Amperes x 1000 (SVC - Max.)	Integral or Remote Main Catalog Designation or Fuse Class (Max. A)	Branch Circuit Breaker Catalog Designation (Max. A)
15 @ 240	—	QO-VH (125) #
10 @ 240	—	QO-VH (125) #
22 @ 240	—	QO-VH (100)
85 @ 240	—	QO (100) *
100 @ 240	1S (200), 1E (200), J (200)	QO (100) *
25 @ 240	QO (225)	QO (100) *
85 @ 240	QO (225)	QO (100) *
100 @ 208Y/120 @ 415V/240	QJ (225)	QO (100) *
10 (17 break) @ 415V/240	—	QO-XD (100)
—	—	QO-VS (63)

\* 240V~ 3 Ph 3 W Grounded "B" phase. # QO includes suffixes: AFI, DF, EPD, EPE, GFI, and PL. # QO-VH includes suffixes: AFI, DF, and GFI.

Size Circuit Breaker for voltage and interrupting Rating. The rating is equal to the lowest interrupting Rating of any Circuit Breaker installed. Refer to branch or main Circuit Breakers for individual ratings. Additional or Replacement Branch or Main Circuit Breaker, or Service Disconnect MUST have an interrupting Rating equal to or greater than that of the Circuit Breaker with the lowest interrupting Rating - priority included. See panelboard interior for Circuit Breaker types.

**UL LISTED**  
**ELECTRIC CABINET**  
**BOX V-2013**  
**IEC 60439-1**

For installation, repairs or alterations, call an electrical contractor or electrician. Minimum continuous loads not to exceed 80% of the ampere rating of any over-current device installed. Los cargos máximos continuos no deben exceder el 80% de la capacidad amperaje de cualquier equipo de sobre corriente instalado.

**SQUARE D™**  
YYWWDS 13 NHA56836

(83) When these 3 P circuit breakers are used as the main circuit breaker of a 3Ø load center, the maximum AIR rating is 65 kA at 240 Vac and 100 kA at 208 Vac.



# QO Wiring Diagrams

## QO Load Centers – Main Lugs

Figure 3 - QO Load Centers 1Ø – Main Lugs

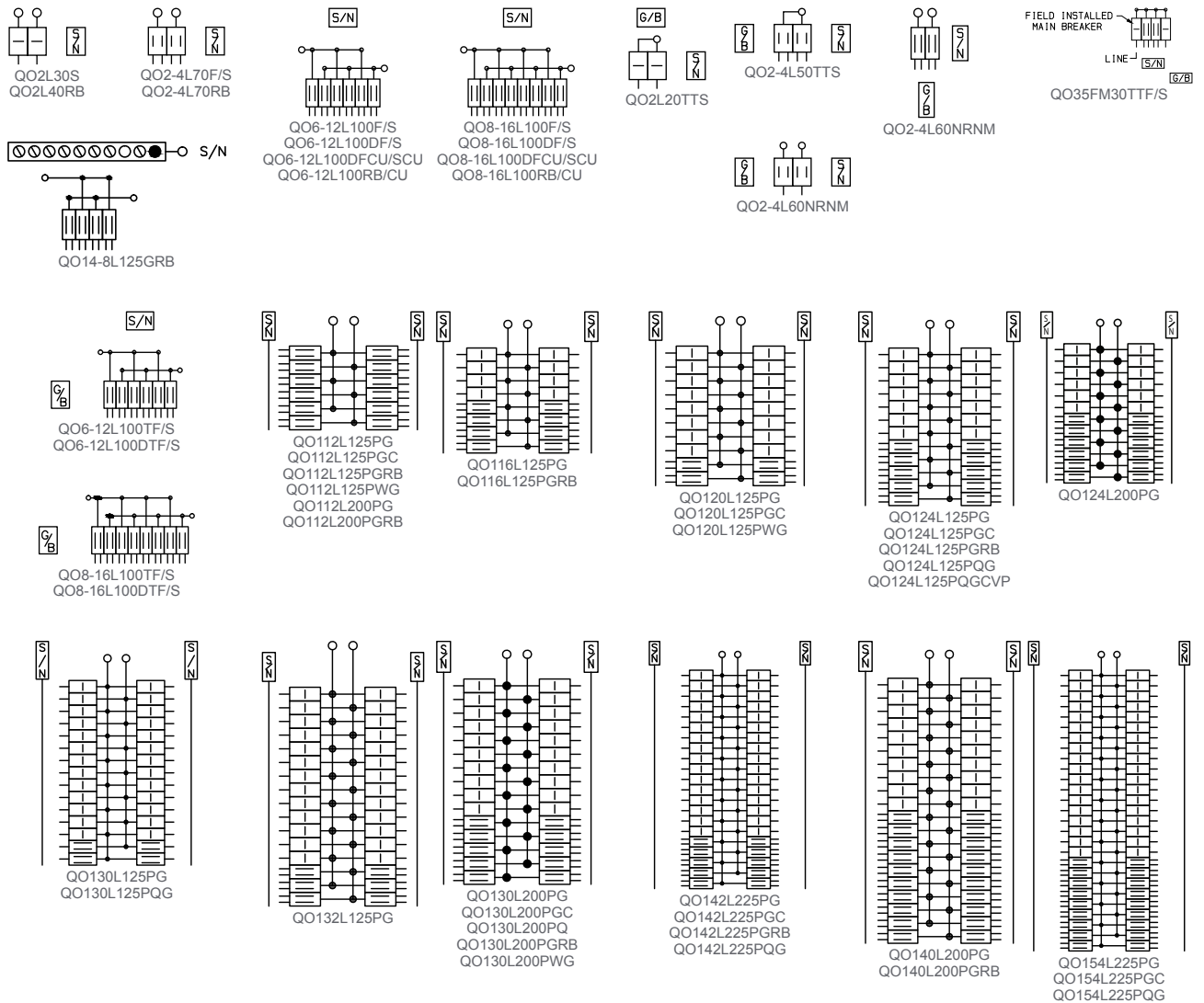

## QO Load Centers – Main Circuit Breaker

**NOTE:** See each catalog number's associated technical drawing online for additional wiring diagram details.

**Figure 4 - QO Load Centers 1Ø – Main Circuit Breaker**

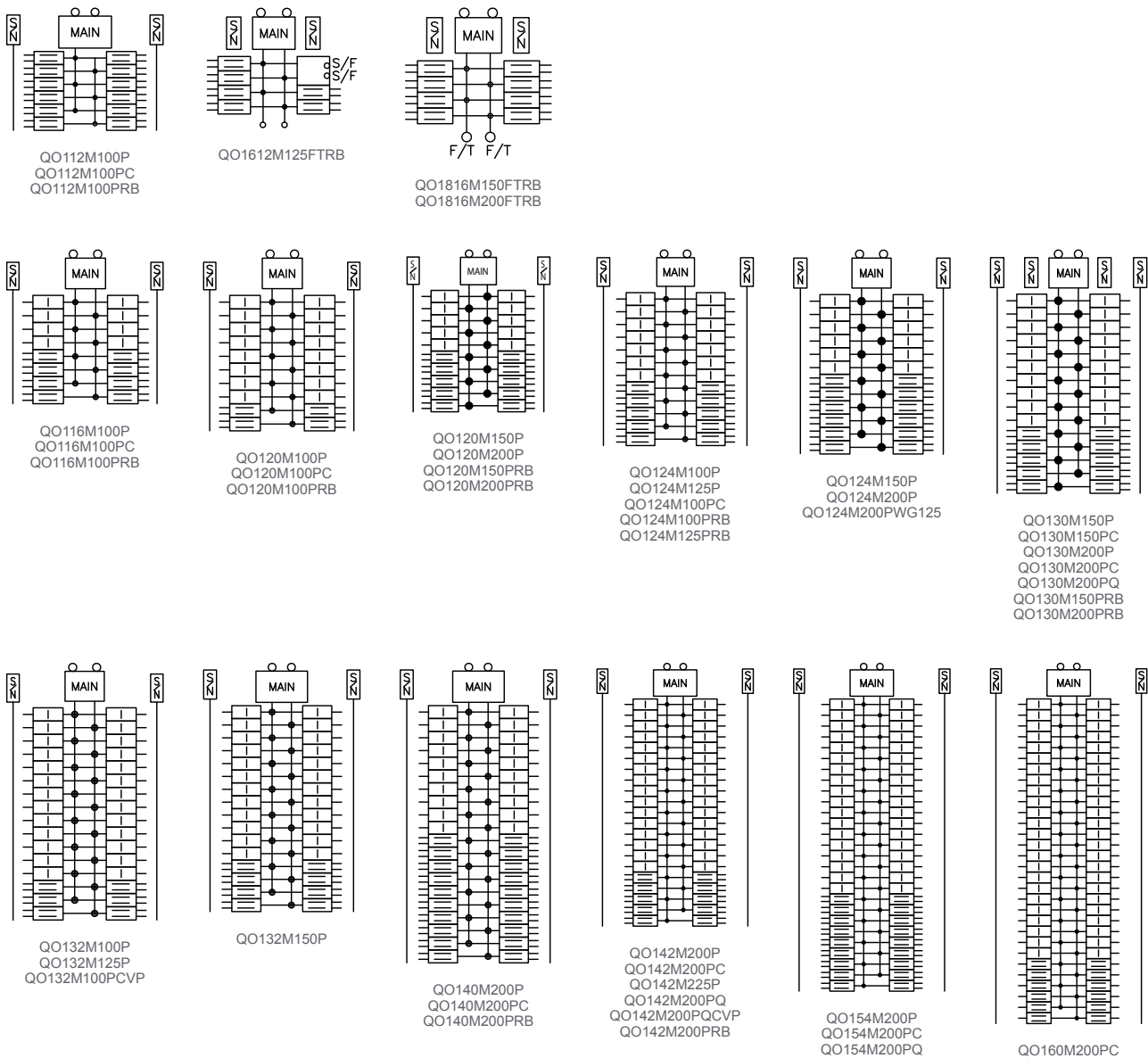

# Backup Power Solutions

Figure 5 - Backup Power Solutions

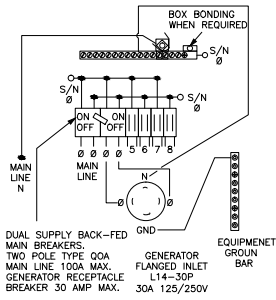

QO1DM10030TRBR

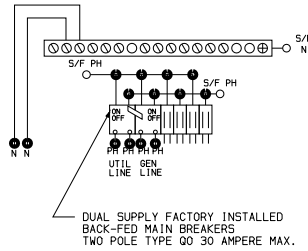

QO4-8M30DS-GP

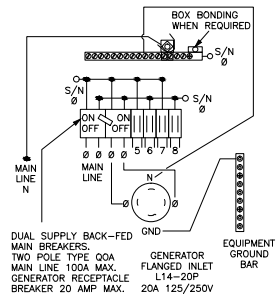

QO1DM10020TRBR

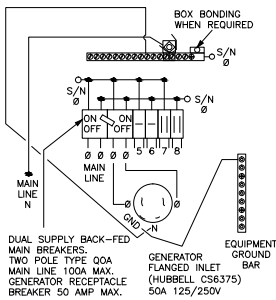

QO1DM10050TRBR

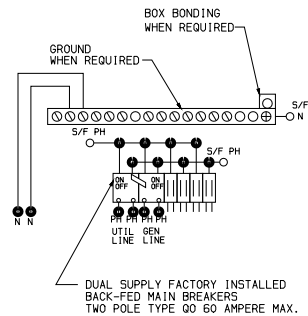

QO4-8M60DS-GP

## QO Load Centers – Main Lugs and Main Circuit Breaker

Figure 6 - QO Load Centers 3Ø – Main Lugs & Main Circuit Breaker

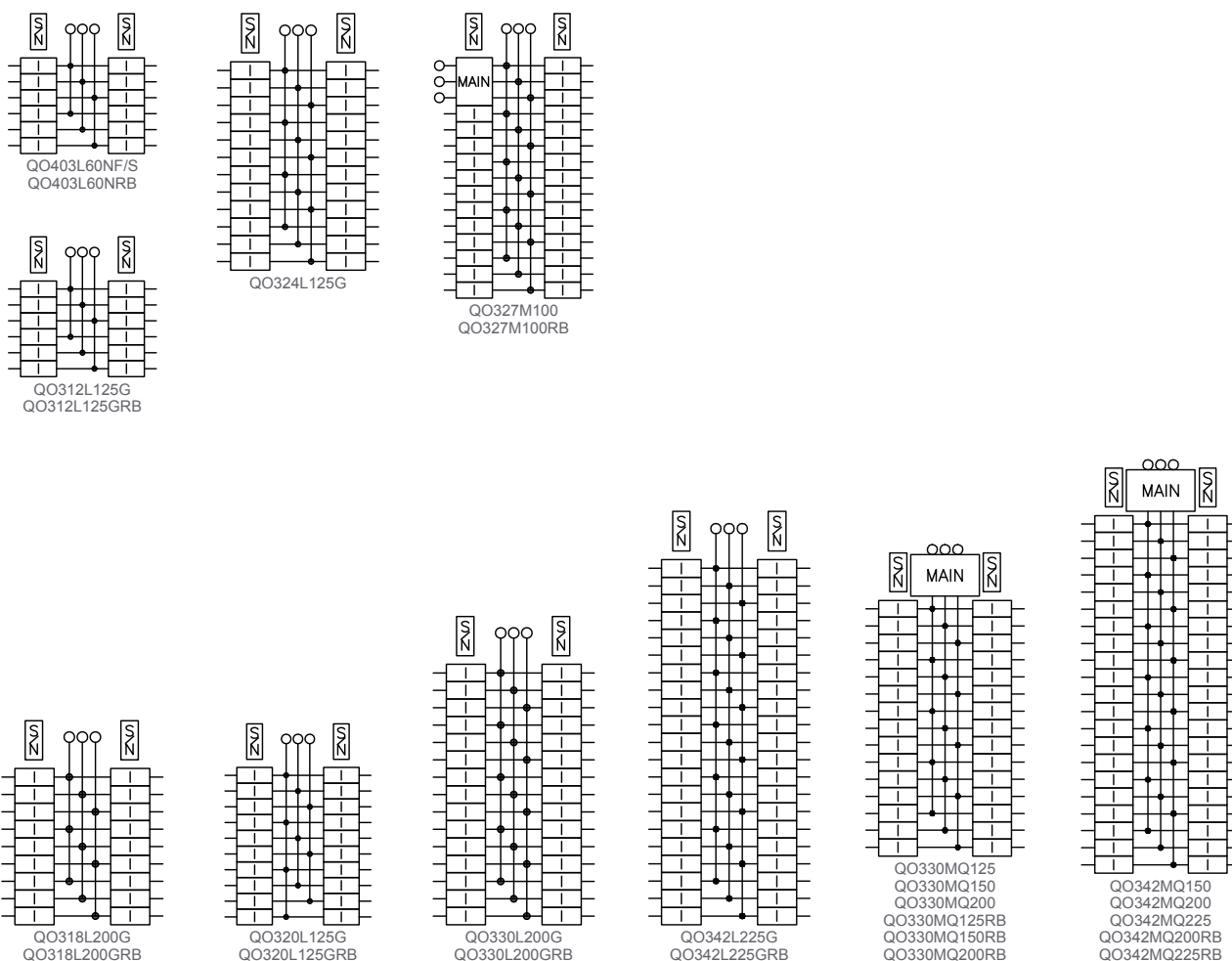

## QO Value Packs, Mounting Bases and Covers

### Value Packs Offer

Different value pack combinations offer an affordable mix of products for load center customers. Value packs are ideal for new construction, upgrades and remodels. Designed to meet various needs, special packs are combined for QO products.

### We've got you covered: flush and surface covers

Indoor QO covers are available in surface or flush mount; these can be purchased separately and limit loss or damage if stored at the job site.

Mono-Flat covers, a high-end alternative with aesthetically pleasing design and low profile surface with concealed mounting screws and door hinges is an alternative to our standard covers.

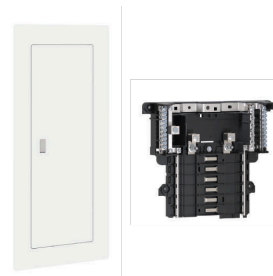

## Plug-on Neutral Load Center Value Packs

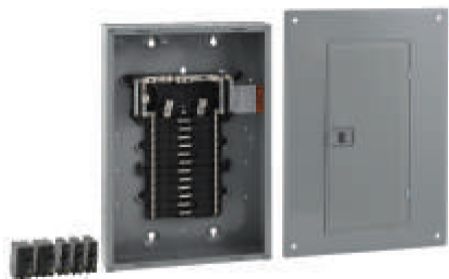

QO124L125PGCVP



QO142M200PCAFVP

**Table 26 - Plug-on Neutral Indoor Load Center Value Packs (Compatible with Plug-on Circuit Breakers and Plug-on Neutral Circuit Breakers)**

Mains Rating	Spaces	Max. 1P Circuits	Max. Tandem Circuit Breakers	Load Center Box, Interior, Cover and Branch Circuit Breakers		Equipment Ground Bar Kit (Order Separately)	Main Wire Size AWG/kcmil		Box No.
				Cat. No.	Included Load Center/Circuit Breakers	Cat. No.	Al	Cu	
<b>QO (Accepts Only QO Plug-On Circuit Breakers) QO — Copper Bus; Convertible Mains — Factory-Installed Main Circuit Breaker, 22 kA Short Circuit Current Rating Convertible appropriate to Main Lugs or QOM Main Circuit Breaker</b>									
125 A	24	34	10	QO124L125PGCVP	(1) QO124L125PGC (3) QO120 (2) QO230	PKGTALP1 Included	6-2/0		7
225 A	42	52		QO142L225PGCVP	(1) QO142L225PGC (3) QO120 (2) QO230	PKGTALP2 Included	4-300		11
<b>Convertible Mains — Factory-Installed Main Circuit Breaker, 22 kA Short Circuit Current Rating Convertible appropriate to Main Lugs or Main Circuit Breaker</b>									
100 A	24	34	10	QO124M100PCVP	(1) QO124M100PC (3) QO120 (2) QO230	PK15GTA	6-2/0		7
	32	38	6	QO132M100PCVP	(1) QO132M100PC (3) QO120 (2) QO230	PK18GTA			8
200 A	42	52	10	QO142M200PCVP	(1) QO142M200PC (3) QO120 (2) QO230	PK23GTA	4-300		11
				QO142M200PCAFVP	(1) QO142M200PC (3) QO120 (2) QO230 (3) QO115PCAFI				

(84) Maximum single pole branch circuits utilizing QO and/or QOT (20 A MAX. NON-CTL) circuit breakers.

(85) See QO/Homeline Enclosure Dimensions and Knockout Information, page 67.

**Table 27 - Plug-on Neutral with Qwik-Grip Indoor Load Center Value Packs (Compatible with Plug-on Circuit Breakers and Plug-on Neutral Circuit Breakers)**

Mains Rating	Spaces	Max. 1P Circuits	Max. Tandem Circuit Breakers	Load Center Box, Interior, Cover and Branch Circuit Breakers		Equipment Ground Bar Kit (Order Separately)	Main Wire Size AWG/kcmil		Box No.
				Cat. No.	Included Load Center/ Circuit Breakers	Cat. No.	Al	Cu	
<b>QO Convertible Mains — Factory-Installed Main Lugs, up to 65 kA Short Circuit Current Rating — Copper Bus, QOM1 Main Frame Size, Convertible to Main Circuit Breaker</b>									
125 A	24	34	10	QO124L125PQGCV	(1) QO124L125PQGC (3) QO120 (2) QO230 and (1) PKQGA Qwik-Grip assembly kit	PKGTALP1	6-2/0		7Q
<b>QO Convertible Mains — Factory-Installed Main Circuit Breaker, 22 kA Short Circuit Current Rating — Copper Bus, QOM2 Main Frame Size, Convertible to Main Lugs or Main Circuit Breaker</b>									
200 A	42	52	10	QO142M200PQCVP	(1) QO142M200MQC (3) QO120 (2) QO230 and (1) PKQGA Qwik-Grip assembly kit	PK23GTA	4-300		11Q

(86) See QO/Homeline Enclosure Dimensions and Knockout Information, page 67.

## QO Mounting Bases – UL Recognized Components

Table 28 - QO Mounting Bases

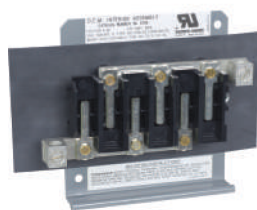

SK9795



QON2L40

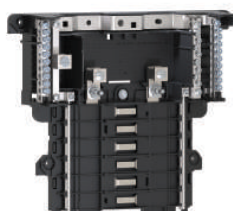

QON112L125PI



QON318L200



QON3B

Voltage System	Main Lug Rating	Spaces	Max. No. 1P Circuits	Mounting Bases Cat. No.	Main Wire Size AWG/kcmil
<b>QO Plug-On Mounting Bases – (Only accepts QO plug-on circuit breakers. Not compatible with QO plug-on neutral circuit breakers.)</b>					
1Ø2W 240 Vac Max. 10 k AIC (without neutral assembly)	70 A	2	2	QON2L70	14–2/0 Cu, 12–2/0 Al
	125 A	4	4	SK9948BW	12–2/0 Al
				SK9842	
		6	6	SK9795	
				SK9801	
8	8	8	SK9796BW	8–3/0 Cu/Al	
SK9797					
<b>QO Plug-On Mounting Bases – (Only accepts QO plug-on circuit breakers. Not compatible with QO plug-on neutral circuit breakers.)</b>					
1Ø3W 240 Vac Max. 10 I AIC	40 A	2	2	QON2L40	14–2/0 Cu, 12–2/0 Al
	70 A		4	QON24L70	
	100 A	6	12	QON612L100	8–1/0 Cu/Al
		8	16	QON816L100	
<b>QO Plug-On Neutral Mounting Bases – (Compatible with QO plug-on circuit breakers and QO plug-on neutral circuit breaker.)</b>					
1Ø3W 240 Vac Max. 10 k AIC	125 A	12	24	QON112L125PI	6–2/0 Cu/Al
		20		QON120L125PI	
	200 A	12		QON112L200PI	4–250 Cu/Al
		24		QON124L200PI	
		30	40	QON124L200PDL	(2) 4–300 Cu/Al
				QON120L200PI	4–250 Cu/Al
	225 A	42	52	QON142L225PI	4–300 Cu/Al
		54	72	QON154L225P	
				QON160L225P	
		60			
<b>QO Plug-On Mounting Bases – (Only accepts QO plug-on circuit breakers. Not compatible with QO plug-on neutral circuit breakers.)</b>					
3Ø3W 240 Vac Max. 10 k AIC (without neutral assembly)	125 A	12	12	QON312L125	6–2/0 Cu/Al
		20	20	QON320L125	
		24	24	QON324L125	
	200 A	18	18	QON318L200	4–250 Cu/Al
		24	24	QON324L200	
		30	30	QON330L200	
		42	42	QON324L205	
	225 A				
	<b>QO Plug-On Mounting Bases – (Only accepts QO plug-on circuit breakers. Not compatible with QO plug-on neutral circuit breakers.)</b>				
3Ø4W 240 Vac Max. 10 k AIC	60 A	3	3	QON403L60N	14–1 Cu, 12–1 Al
	125 A	12	12	QON312L125I	6–2/0 Cu/Al
		20	20	QON320L125I (87)	
		24	24	QON324L125I	
	200 A	30	30	QON330L200I (87)	4–250 Cu/Al
	225 A	42	42	QON342L225I	4–300 Cu/Al
<b>QO Plug-On Mounting Bases – (Only accepts QO plug-on circuit breakers. Not compatible with QO plug-on neutral circuit breakers.)</b>					

(87) Also IEC rated and CE marked for IEC 60439-1. Use only Square D brand Type QOXC, QOXD, QOHX and QOE circuit breakers for 415Y/240 Vac max. systems.

**Table 28 - QO Mounting Bases (Continued)**

Voltage System	Main Lug Rating	Spaces	Max. No. 1P Circuits	Mounting Bases Cat. No.	Main Wire Size AWG/kcmil
1Ø2W 240 Vac Max. 10 k AIC (without neutral assembly)	70 A	1	1	QOMB1	14-2/0 Cu, 12-2/0 Al
		2	2	QOMB2	
		3	3	QOMB3	
<b>QOB Bolt-On Mounting Bases – (Only accepts QOB bolt-on circuit breakers)</b>					
1Ø2W 240 Vac Max. 10 k AIC (without neutral assembly)	100 A	3	3	QON3B	14-1 Cu, 12-1 Al

## Solid Neutral Assemblies

**Table 29 - Solid Neutral Assemblies**

Main Lug Rating	Number of Branch Neutral Terminals	Cat. No.	Main Neutral Lug Wire Size AWG/kcmil	Branch Neutral Terminal Wire Size	
				Cu	Al
125 A	12	SN12125	4-2/0 AWG	14-4 AWG	12-4 AWG
	20	SN20			
200 A	12	SN12200	4 AWG-300 kcmil		
	30	SN30			
225 A	42	SN42			



SN30



SN42



SN12125



SN12200

## Accessories for US Mounting Base for UL 489 C60

**Table 30 - Accessories for US Mounting Base for UL 489 C60**



Description	Cat. No.
Main lug kit for US mounting bases, 1 lug per kit, for 6 AWG to 300 kcmil cable	USMBLK
Terminal cover for US mounting base; provides IP20 ingress protection per IEC 60529; suitable for jumper bars or cable	USMBTC

## QO Load Center Covers



QOC40UFW



QOC20UFWG



QOCMF42UCW

**Table 31 - QO Load Center Covers**

Mains Ratings	Spaces	QO Standard Covers			QO Mono-Flat Covers	
		Flush	Surface	Flush	Gray	White
		Gray Covers		White Covers		
<b>QO 1-Phase Load Center Covers — Convertible Mains</b>						
100 A	12	QOC12UF	QOC12US	—	—	—
	16	QOC20U100F	QOC20U100S	QOC20U100FW	—	—
	20	QOC20U100F	QOC20U100S	QOC20U100FW	—	—
	24	QOC24UF	QOC24US	QOC24UFW	—	—
	32	QOC32UF	—	QOC32UFW	—	—
125 A	12	QOC16UF	QOC16US	QOC16UFW	—	—
	16	QOC24UF	QOC24US	QOC24UFW	—	—
	20	QOC20U100F	QOC20U100S	QOC20U100FW	—	—
	24	QOC24UF	QOC24US	QOC24UFW	—	—
	30	QOC30U125C	—	—	—	—
	32	QOC32UF	—	QOC32UFW	—	—
150 A	20	QOC30UF	QOC30US	QOC30UFW	QOCMF30UC	QOCMF30UCW
	24	QOC30UF	QOC30US	QOC30UFW	QOCMF30UC	QOCMF30UCW
	30	QOC30UF	QOC30US	QOC30UFW	QOCMF30UC	QOCMF30UCW
	32	QOC40UF	QOC40US	QOC40UFW	—	—

**Table 31 - QO Load Center Covers (Continued)**

Mains Ratings	Spaces	QO Standard Covers			QO Mono-Flat Covers	
		Flush	Surface	Flush	Gray	White
		Gray Covers		White Covers		
200 A	12	QOC30UF	QOC30US	QOC30UFW	QOCMF30UC	QOCMF30UCW
	20	QOC30UF	QOC30US	QOC30UFW	QOCMF30UC	QOCMF30UCW
	24	QOC30UF	QOC30US	QOC30UFW	QOCMF30UC	QOCMF30UCW
	30	QOC30UF	QOC30US	QOC30UFW	QOCMF30UC	QOCMF30UCW
	40	QOC40UF	QOC40US	QOC40UFW	—	—
	42	QOC42UF	QOC42US	QOC42UFW	QOCMF42UC	QOCMF42UCW
	54	QOC54UF	—	QOC54UFW	QOCMF54UC	QOCMF54UCW
	60	QOC60UF	—	—	QOCMF60UC	QOCMF60UCW
225 A	40	QOC42UF	QOC42US	QOC42UFW	QOCMF42UC	QOCMF42UCW
	42	QOC42UF	QOC42US	QOC42UFW	QOCMF42UC	QOCMF42UCW
	54	QOC54UF	—	QOC54UFW	QOCMF54UC	QOCMF54UCW
<b>QO Rise Panel (Wide Gutter) Covers</b>						
125 A	12	QOC20UFWG	—	QOC20UFWGW	NQC20FWG	NQC20FWGW
	20	QOC20UFWG	—	QOC20UFWGW	NQC20FWG	NQC20FWGW
200 A	24	QOC30UFWG	—	QOC30UFWGW	NQC30FWG	NQC30FWGW
	30	QOC30UFWG	—	QOC30UFWGW	NQC30FWG	NQC30FWGW
<b>QO 3-Phase Load Center Covers — Fixed Mains</b>						
125 A	12	QOC16UF	QOC16US	QOC16UFW	—	—
	20	QOC24UF	QOC24US	QOC24UFW	—	—
	24	QOC24UF	QOC24US	QOC24UFW	—	—
200 A	18	QOC30UF	QOC30US	QOC30UFW	—	—
	30	QOC30UF	QOC30US	QOC30UFW	—	—
225 A	42	QOC42UF	QOC42US	QOC42UFW	—	—
<b>QO 3-Phase Load Center Covers — Convertible Mains</b>						
100 A	27	QOC30UF	QOC30US	QOC30UFW	—	—
125 A	30	QOC342MQF	QOC342MQS	—	—	—
150 A	30	QOC342MQF	QOC342MQS	—	—	—
	42	QOC342MQF	QOC342MQS	—	—	—
200 A	30	QOC342MQF	QOC342MQS	—	—	—
	42	QOC342MQF	QOC342MQS	—	—	—
225 A	42	QOC342MQF	QOC342MQS	—	—	—

# Homeline Load Centers

## Homeline Product Description

This section provides an overview of the Homeline Load Center features, an overview of the catalog number guide, and general information about the product.

### Introduction to Homeline Load Centers

Homeline Load Centers are built on Square D reputation for reliability, innovation, and leadership in circuit protection.

Homeline Load Centers from Square D are UL Listed panelboards. They are designed to meet residential requirements to help protect electrical systems, equipment, and people.

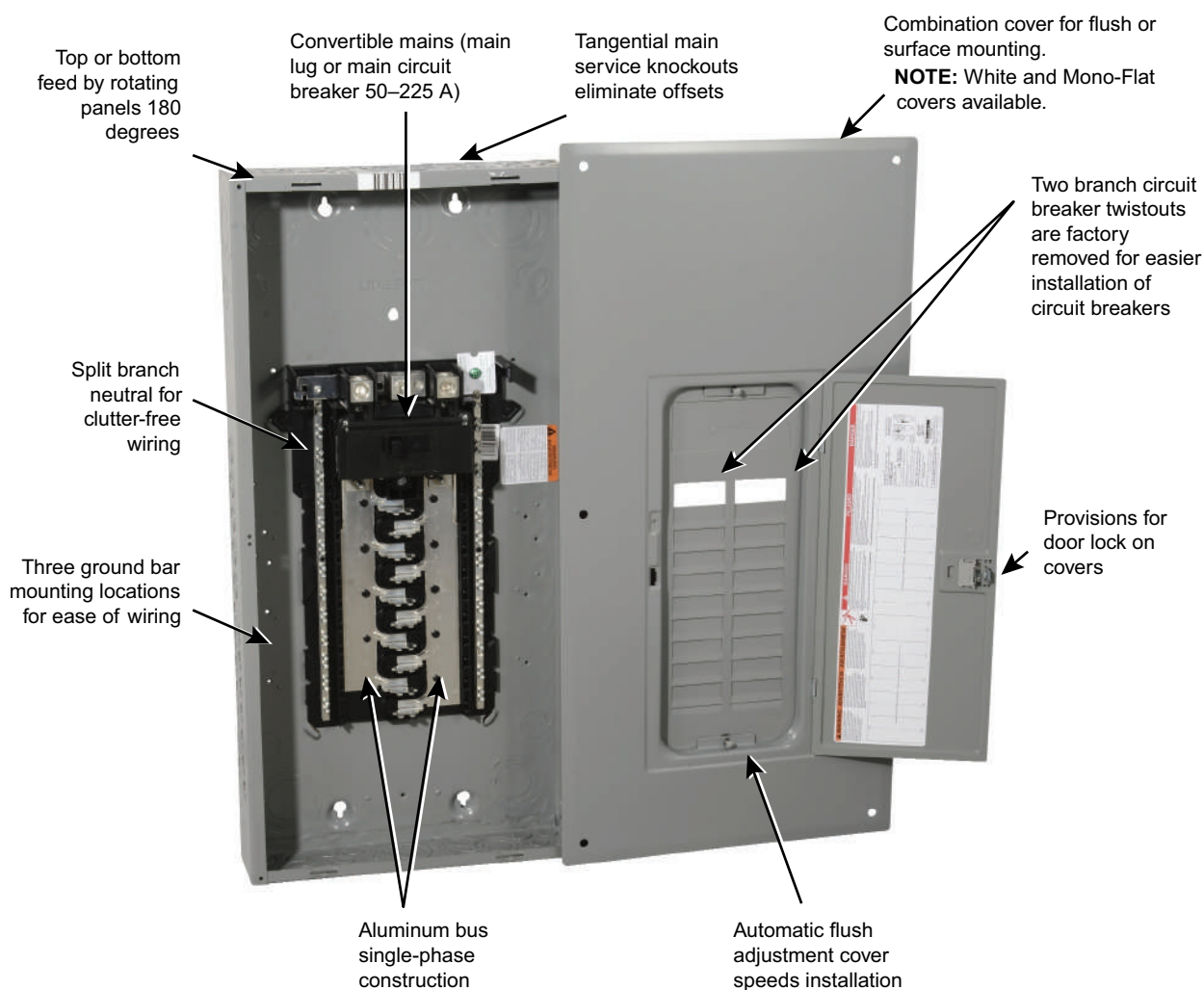

**Other Features:**

**UL Listed Only for Square D Breakers:** 1-in. format breakers trip to center position.

**Standard 22 kA /10 kA AIR SCCR:** Standard 22/10 kA AIR series rating on main circuit breaker panels increases application capability (branch circuit breakers 10 kA / main circuit breaker 22 kA).

**Hinges and ground bars:** Side hinge doors on outdoor convertible main panels. Equipment grounding bar included with main lug load centers.

**Screws:** Single captive screw interior mounting on indoor panels to ease removal. Combination slot/square drive neutral, ground, and cover screws for positive drive and improved torque.

**Accepts Plug-on Neutral (PoN) CAFI and Dual Function Breakers, and circuit breakers with pigtails**

## Catalog Number Guide – Homeline Load Centers

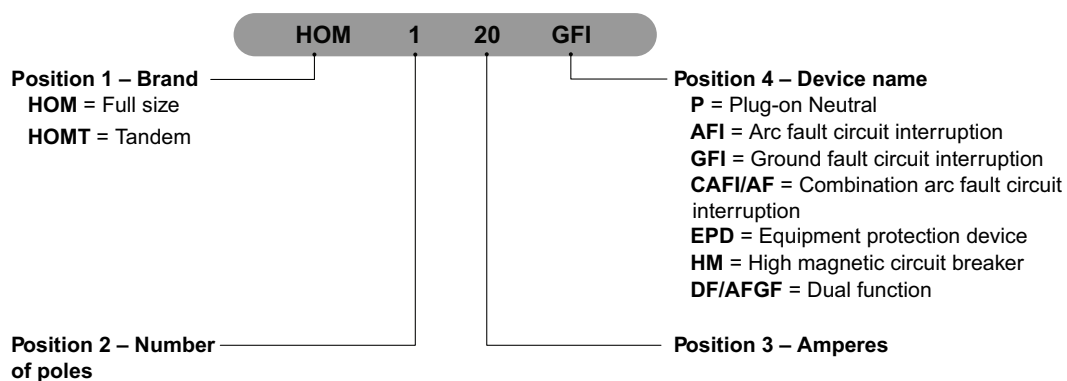
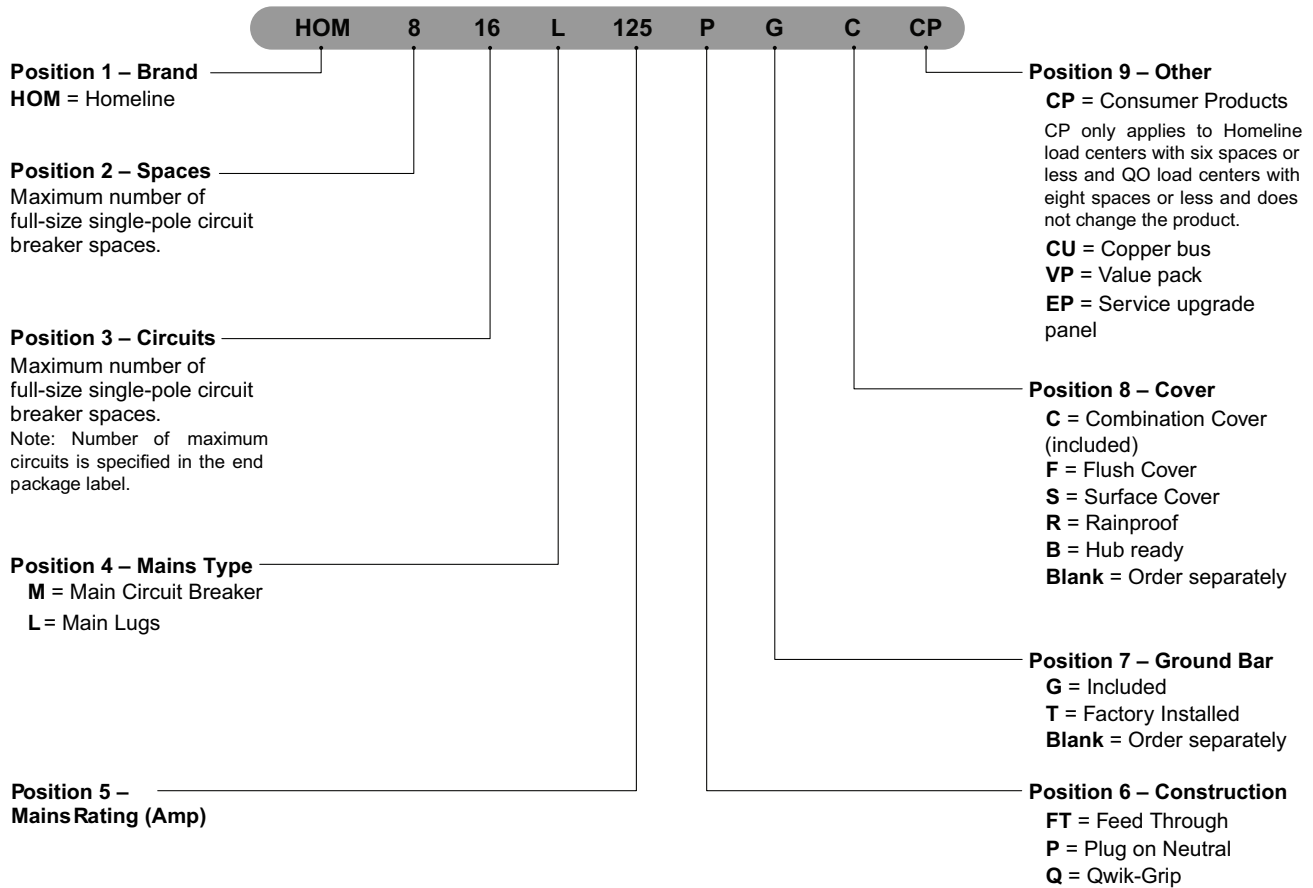

## General Information



HOM3060L125PC



HOM230

**Type:**

Circuit breaker load centers for use on AC systems. They are UL Listed under file E-6294 (panelboards) and meet Federal Specifications W-P-115b NEMA Type 1, Class 2.

**Service:**

120 Vac, 1Ø2W  
 120 / 240 Vac, 1Ø3W

**Ratings:**

Main lugs: 70–225 A  
 Main circuit breaker: 50–225 A

**UL Listed:**

- File E-6294 (panelboards)
- UL 67 Standard for Panelboards establishes requirements for electrical distribution panels
- Suitable for use as service equipment
- 75°C wire rating

**Class CTL:**

UL Listed Class CTL load centers

Meets the 2020 National Electrical Code (NEC) article for Lighting and Appliance Branch Circuit panelboards

**Main Circuit Breaker Kits:**

50–225 A main circuit breaker kit is 22,000 AIR series rated with 10,000 AIR branch circuit breakers.

**Table 32 - Branch Circuit Breakers**

10,000 AIR	
HOM	1-pole, 15–50 A
	2-pole, 15–125 A
HOMT	1-pole, 15–30 A
	2-pole, 15–50 A
HOM-GFI	1-pole, 15–20 A
	2-pole, 15–50 A
HOM-AFI	1-pole, 15–20 A
HOM-CAFI	1-pole, 15–20 A
	2-pole, 15–20 A
HOM-P	1-pole, 15–20 A
HOM-BB	2-pole, 150–200 A
HOM-DF	1-pole, 15–20 A
HOM-HM	1-pole, 15–20 A
HOM-EPD	1-pole, 15–20 A
	2-pole, 15–50 A

## Homeline Indoor and Outdoor Load Centers

### NEMA Type 1 – Indoor

NEMA Type 1 enclosures are typically used to help protect controls and terminations from objects and personnel. This style of enclosure, while offering a latching door, does not have a gasket sealing surface. NEMA 1 enclosures are used in applications where sealing out dust, oil, and water is not required.



### NEMA Type 3R – Rainproof

NEMA Type 3R enclosures are typically used in outdoor applications for wiring and junction boxes. This style of enclosure help provide protection against falling rain, sleet, snow, and external ice formation. In an indoor application, this can help protect against dripping water. This style of enclosure does not have a gasket sealing surface. Some models have hasps for padlocking.



## Indoor Enclosures (NEMA Type 1)



### Homeline Plug-on Neutral Load Centers

Homeline plug-on neutral load centers offer time-savings for plug-on neutral combination arc fault (CAFI) and dual function circuit breaker installation. Our innovative, split neutrals are designed to save you time and wire, allowing plug-on neutral circuit breakers to connect directly to the neutral bar without the pigtail.



### Qwik-Grip wire management system available

Save time and simplify your work by eliminating knockouts, installing wire connectors and help prevent pulling wire into the load center.

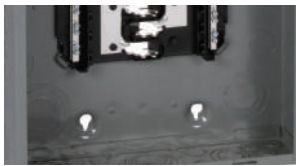

### Material, Finish, and Knockouts

The enclosures are sheet steel with knockouts at the top, bottom, back, and sides. Homeline finish consists of gray baked enamel electrodeposited over cleaned, phosphatized steel. Most indoor enclosures are 14.25 in. (362 mm) wide. Homeline enclosures can be rotated to allow top or bottom feed. Homeline load center interiors have tin and copper plated aluminum bus bars.



### Flush and surface covers

Indoor Homeline covers with latch are available in surface or flush mount and are included with our load centers. Doors to cover circuit breaker handles, except on 2-4, 4-8, and 6-12 circuit models. Triple lead covers crews for fast cover installation.



### Filter plates

Snap-in style filler plates are accessories purchased separately available to cover unused spaces. HOMFP and QOFP filler plates available for branch circuit breaker spaces in all covers. QOM1FP filler plates available for 100-125 A convertible load center covers. QOM2FP filler plates available for 150-225 A convertible load center covers.



### Different colors and styles

Homeline covers are available in gray and white colors. Mono-Flat covers, a high-end alternative with aesthetically pleasing design and low profile surface with concealed mounting screws and door hinges are an alternative to the standard covers.

## Outdoor Enclosures (NEMA Type 3R)



### Homeline Plug-on Neutral

Homeline plug-on neutral load centers offer time-savings for plug-on neutral combination arc fault (CAFI) and dual function circuit breaker installation. These innovative, split neutrals are designed to save you time and wire, allowing plug-on neutral circuit breakers to connect directly to the neutral bar without the pigtail.

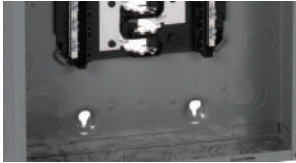

### Material, Finish, and Knockouts

Galvannealed steel enclosure includes interior trim and door with a gray baked enamel electrodeposited over cleaned, phosphatized steel. Homeline load center interiors have tin and copper plated aluminum bus bars.



### Stainless steel latch

Stainless steel door latch on the enclosure provides a secure closure and maximum durability.



### Wiring access without door removal

Convertible main panels are side-hinge door devices, providing full wiring access without door removal.





### Bolt-On Hubs



NEMA 3R — are rainproof devices have provisions for interchangeable bolt-on hub. Square D type rain-tight bolted hubs provide fast and convenient top feed conduit connection. Hubs are available for 0.75 in. (19 mm) to 4 in. (102 mm) conduit size. No gasket is required with hubs from 0.75 in. (19 mm) to 2.50 in. (64 mm) when used on NEMA Type 3R load centers.

## Fixed Mains vs. Convertible Mains – Single Phase

**Table 33 - Single-Phase – Homeline Load Centers, Fixed Mains (70–125 A)**

Indoor NEMA 1	Rainproof NEMA 3R
	
<b>Standards</b>	
UL 67 Listed <ul style="list-style-type: none"> <li>• File E-6294</li> <li>• 75°C wire rating</li> </ul>	
<b>Short Circuit Current Rating</b>	
Main lugs: up to 10,000 AIR	
<b>Interior</b>	
Tin plated aluminum bus	
<b>Mains</b>	
<ul style="list-style-type: none"> <li>• Factory-installed fixed main lugs</li> <li>• Top mains positioning only</li> <li>• Top or bottom feed</li> <li>• A backfed main circuit breaker can be field installed in a 6-12 load center using the HOM1RK retaining kit</li> </ul>	
<b>Covers</b>	
Flush and surface cover	

**Table 34 - Single-Phase – Homeline Load Centers, Convertible Mains (100–225 A)**

Indoor NEMA 1	Rainproof NEMA 3R
	
<b>Standards</b>	
UL 67 Listed <ul style="list-style-type: none"> <li>• File E-6294</li> <li>• Suitable for use as service equipment</li> <li>• 75°C wire rating</li> </ul>	
<b>Short Circuit Current Rating</b>	
<ul style="list-style-type: none"> <li>• Main lugs: up to 10,000 AIR</li> <li>• Main circuit breaker: 22,000 AIR standard</li> </ul>	
<b>Interior</b>	

**Table 34 - Single-Phase – Homeline Load Centers, Convertible Mains(100–225 A) (Continued)**

Indoor NEMA 1		Rainproof NEMA 3R	
<ul style="list-style-type: none"> <li>• Tin plated aluminum bus</li> <li>• Removable interior with single, captive mounting screw</li> <li>• Split branch neutral with up to 50% more terminations than required</li> <li>• Multiple mounting locations for equipment ground bar kits: left, right, bottom</li> </ul>			
<b>Mains</b>			
Factory-installed main lugs convertible to main circuit breaker			
Load Center Amperage		Main Circuit Breaker Kit Amperage	
125		50–125	
150		10–150	
200		100–200	
225		100–225	
Factory-installed main circuit breaker convertible to main lugs			
Main Circuit Breaker Amperage	Main Lug Kit Amperage		Load Center Amperage
100	125		100
125	125		125
150	225		150
200	225		200
225	225		225
<b>Covers</b>			
<ul style="list-style-type: none"> <li>• Combination flush and surface cover included with load centers</li> <li>• Optional door lock kit for indoor load centers</li> <li>• Easy to open door latch</li> </ul>			

## Technical Information

### Indoor, HOM Fixed Mains (70-125 A) – Main Lugs



HOM24L70F



HOM612L100F



HOM48L125GC

**Table 35 - HOM Standard Load Center Main Lugs, Fixed Mains (1Ø3W—120/240 Vac Indoor—UL Listed)**

Mains Rating	Spaces	Max. Single Pole Circuits	Max. Tandem Circuit Breakers	Load Center Box, Interior	Main Wire Size AWG/kcmil		Equipment Ground Bar Kit (Order Separately)	Box No.
					Al	Cu		
<b>Main Lugs—10 kA Short Circuit Current Rating Order HOM Circuit Breakers</b>								
70 A	2	4	2	HOM24L70F/S (91), (92)	12–3	14–4	PK3GTA1	2
100 A	6	12	6	HOM612L100F/S (91), (93)	6–2/0	8–1	PK7GTA	4
125 A	4	8	4	HOM48L125GC	12–2/0	14–2/0	PK7GTA included	21

(88) Maximum single pole branch circuits utilizing HOM and/or HOMET circuit breakers.  
 (89) C at end of catalog number indicates combination flush/surface cover included with device.  
 (90) See QO/Homeline Enclosure Dimensions and Knockout Information, page 67.  
 (91) F/S at end of catalog number indicates to order F for flush device or S for surface device. The cover does not have a door.  
 (92) HOM-GFI and HOM-AFI branch circuit breakers are limited to number 10 maximum wire.  
 (93) 70 A maximum branch circuit breaker, 100 A maximum back feed main circuit breaker.

## Indoor, HOM Convertible Mains (125–225 A) – Main Lugs



HOM2040L225PGC



HOM4284L225PGC

**Table 36 - HOM Plug-on Neutral Load Center Main Lugs, Convertible Mains (1Ø3W–120/240 Vac Indoor—UL Listed)**

Mains Rating	Spaces	Max. Single Pole Circuits	Max. Tandam Circuit Breakers	Load Center Box, Interior and Cover	Main Wire Size AWG/kcmil		Equipment Ground Bar Kit (Order Separately)	Box No.
					Al	Cu		
<b>Convertible Mains—Factory-installed Main Lugs QOM1 Main Frame Size—Convertible to Main Circuit Breaker</b>								
125 A	8	16	8	HOM816L125PC	6–2/0	6–1	PK9-27GTA(L)	6
	12	24	12	HOM1224L125PC				
	16	32	16	HOM1632L125PC		6–1/0		8
	20	40	20	HOM2040L125PC				
	30	60	30	HOM3060L125PC				
<b>Convertible Mains—Factory-installed Main Lugs QOM2 Main Frame Size—Convertible to Main Circuit Breaker</b>								
225 A	30	60	30	HOM3060L225PC	4–300	4–250	PK9-27GTA(L)	10
	40	80	40	HOM4080L225PC				12
	42	84	42	HOM4284L225PC				
	60	120	60	HOM60120L225PC				
<b>Convertible Mains—Factory-installed Main Lugs—Ground Bar Included QOM1 Main Frame Size—Convertible to Main Circuit Breaker</b>								
125 A	8	16	8	HOM816L125PGC	6–2/0	6–1	PKGTALP1 Included	6
	12	24	12	HOM1224L125PGC				
	20	40	20	HOM2040L125PGC		6–1/0		8
	24	80	24	HOM2448L125PGC				
<b>Convertible Mains—Factory-installed Main Lugs—Ground Bar Included QOM2 Main Frame Size—Convertible to Main Circuit Breaker.</b>								
225 A	30	60	30	HOM3060L225PGC	4–300	4–250	PKGTALP2 Included	10
	16	32	16	HOM1632L225PGC				PKGTALP1 Included
	20	40	20	HOM2040L225PGC				
	40	80	40	HOM4080L225PGC			PKGTALP3 Included	
	42	84	42	HOM4284L225PGC				

(94) Maximum single pole branch circuits utilizing HOM and/or HOMET circuit breakers.  
 (95) C at end of catalog number indicates combination flush/surface cover included with device.  
 (96) See QO/Homeline Enclosure Dimensions and Knockout Information, page 67.

## Indoor, HOM Convertible Mains (100–200 A) – Main Breaker



HOM3060M125PC



HOM4284M225PC

**Table 37 - HOM Plug-on Neutral Load Center Main Breaker, Convertible Mains (1Ø3W–120/240 Vac Indoor–UL Listed)**

Mains Rating	Spaces	Max. Single Pole Circuits	Max. Tandam Circuit Breakers	Load Center Box, Interior and Cover	Main Wire Size AWG/ kcmil		Equipment Ground Bar Kit (Order Separately)	Box No.
					Al	Cu		
<b>Main Circuit Breaker – 22 kA Short Circuit Current Rating</b>								
<b>Convertible Mains – Factory-installed Main Circuit Breaker</b>								
<b>QOM1 Main Frame Size – Convertible to Main Lugs or Lower Amperage Main Circuit Breaker</b>								
100 A	8	16	8	HOM816M100PC	6–1	6–3	PK9-27GTA(L)	5
	12	24	12	HOM1224M100PC		6–2/0		6
	20	40	20	HOM2040M100PC		6–3		7
	24	48	24	HOM2448M100PC	6–2/0			8
	30	60	30	HOM3060M100PC	6–2/0			10
125 A	24	48	24	HOM2448M125PC	6–2/0	6–1/0	PK9-27GTA(L)	8
	30	60	30	HOM3060M125PC		6–2/0		10
<b>Convertible Mains – Factory-installed Main Circuit Breaker</b>								
<b>QOM2 Main Frame Size – Convertible to Main Lugs or Lower Amperage Main Circuit Breaker</b>								
150 A	30	60	30	HOM3060M150PC	4–250		PK9-27GTA(L)	10
200 A	20	40	20	HOM2040M200PC	4–250			9
	30	60	30	HOM3060M200PC				10
	40	80	40	HOM4080M200PC				12
	42	84	42	HOM4284M200PC				12
	60	120	60	HOM60120M200C				25
225 A	42	84	42	HOM4284M225PC	4–300	4–250	12	

(97) Maximum single pole branch circuits utilizing HOM and/or HOMET circuit breakers.  
 (98) C at end of catalog number indicates combination flush/surface cover included with device.  
 (99) See QO/Homeline Enclosure Dimensions and Knockout Information, page 67.

## Indoor, HOM Convertible Mains (125–200 A with Qwik-Grip)

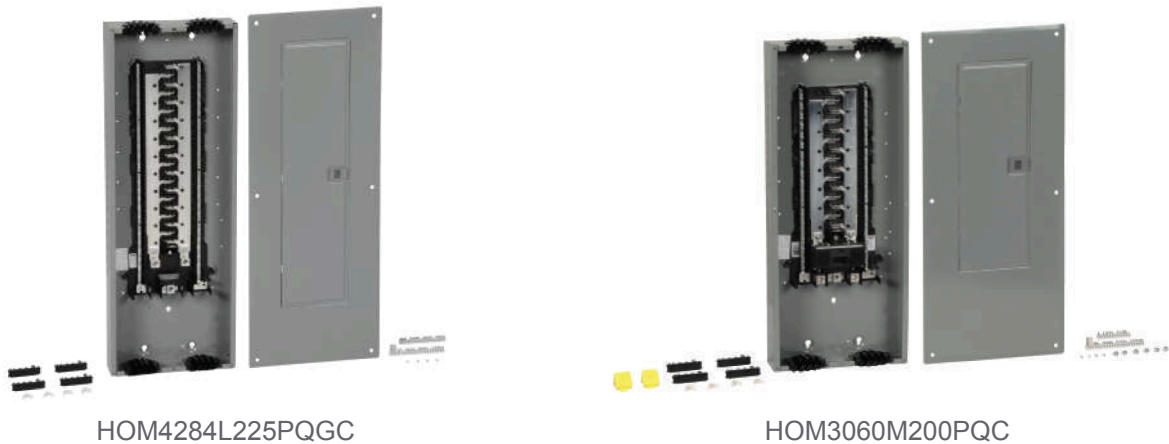

**Table 38 - HOM Plug-on Neutral Load Centers with Qwik-Grip (1Ø3W–120 / 240 Vac Indoor— UL Listed)**

Mains Rating	Spaces	Max. 1P Circuit	Max. Tandem Circuit Breakers	Load Center Box, Interior and Cover	Main Wire Size AWG/kcmil		Equipment Ground Bar Kit	Box No.
					Al	Cu		
125 A	34	48	24	HOM2448L125PQGC	6–2/0	6–1/0	PKGTALP2 included	8Q
	40	60	30	HOM3060L125PQGC		6–2/0		10Q
<b>Convertible Mains—Factory-Installed Main Lugs, 10 kA Short Circuit Current Rating— QOM2 Main Frame Size, Convertible</b>								
225 A	30	60	30	HOM3060L225PQGC	4–300	4–250	PKGTALP2 included	10Q
	40	80	40	HOM4080L225PQGC				PKGTALP3 included
	42	84	42	HOM4284L225PQGC				
<b>Convertible Mains—Factory-Installed Main Circuit Breaker, 22 kA Short Circuit Current Rating— QOM2 Main Circuit Breaker Frame Size, Convertible to Main Lugs or Main Circuit Breaker</b>								
200 A	30	60	30	HOM3060M200PQC	4–250		PK9-27GTA(L)	10Q
	40	80	40	HOM4080M200PQC				
	42	84	42	HOM4284M200PQC	4–300	4–250		12Q

**Table 39 - Homeline Service Upgrades Load Centers (1Ø3W—120/240 Vac Special Applications—UL Listed)**

Mains Rating	Spaces	Max. IP Circuits	Max. Tandem Circuit Breakers	Load Center Box and Interior	Extra Long Cover with Door (Order Separately)		Main Wire Size AWG/ Kcmil		Equipment Ground Bar Kit (Order Separately)	Box No.
					Flush	Surface	Al	Cu		
<b>Convertible Mains—Factory-Installed Main Circuit Breaker—22 KA QOM2 Main Frame Size—Convertible to Main Lugs or Lower Amperage Main Circuit Breaker —Copper Bus <sup>(102)</sup></b>										
200 A	30	60	30	HOM3060M200PCEP <sup>(103)</sup>	HOMC30UFL	—	4–250		PK9-27GTA(L)	26

<sup>(100)</sup>Maximum single pole branch circuits utilizing QO and/or QOT circuit breakers.

<sup>(101)</sup>See QO/Homeline Enclosure Dimensions and Knockout Information, page 67.

<sup>(102)</sup>22 k AIR main circuit breaker UL Listed for use ahead of QO, QOT and QO-PL 10 k AIR branch circuit breakers to permit their application on systems with up to 22 kA available fault current.

<sup>(103)</sup>Ships with standard length cover.

## 1Ø, Field-Installed Mains Kits

**Table 40 - Field-Installed Main Circuit Breaker Kits, 1Ø  
QOM1 Frame Size — (Use with Convertible Main Load Centers only)**



QOM50VH

Main Circuit Breaker Rating	Convertible Load Center Mains Rating	22 k AIR	Lug Wire Size AWG/kcmil
		Main Circuit Breaker	
50 A	100–125	QOM50VH	12–2/0 Al or Cu
60 A		QOM60VH	
70 A		QOM70VH	
80 A		QOM80VH	
90 A		QOM90VH	
100 A		QOM100VH	
110 A	125	QOM110VH	
125 A		QOM125VH	

**Table 41 - Field-Installed Main Circuit Breaker Kits, 1Ø  
QOM2 Frame Size — (Use with Convertible Main Load Centers only)**



QOM2100VH

Main Circuit Breaker Rating	Convertible Load Center Mains Rating	22 k AIR	Lug Wire Size AWG/kcmil
		Main Circuit Breaker	
100 A	150–225	QOM2100VH	4–300 Al or Cu
125 A		QOM2125VH	
150 A		QOM2150VH	
175 A	200–225	QOM2175VH	
200 A		QOM2200VH	
225 A		QOM2225VH	

**Table 42 - Field-Installed Main Lug Kits, 1Ø**



QOL125

Field-Installed Main Type	Frame Size	Main Ampere Rating	Use on Convertible Load Center with Mains Rating	Cat. No.	Lug Wire Size AWG/kcmil
Main Lugs <sup>(108)</sup>	—	125 A	100–125 A	QOL125	6–2/0 Al or Cu
				QOL125VD	4–4/0 Al or Cu
	—	225 A	150–225 A	QOL225	6–300 Al or Cu

(104) Do not exceed the load center mains rating.

(105) 22 k AIR main circuit breaker UL Listed for use ahead of QO, QOT and QO-PL 10 k AIR branch circuit breakers to permit their application on systems with up to 22 kA available fault current.

(106) Wire range listed for QOM circuit breaker kits is the wire range of that circuit breaker. To find out maximum wire size permitted in a particular load center per UL, see Main Wire Size in that load center table.

(107) Add suffix 1021 for 120, 208 or 240 Vac shunt trip.

(108) If main circuit breaker knockout has been removed from the load center's trim, order appropriate filler plate from QO/Homeline Accessories, page 72.

## Rainproof, HOM Fixed and Convertible Mains (70–225 A) Main Lugs



**Table 43 - HOM Standard Load Center Main Lugs, Fixed Mains (1Ø3W–120/240 Vac Rainproof UL—Listed)**

Mains Rating	Spaces	Max. Single Pole Circuits	Max. Tandam Circuit Breakers	Load Center Box, Interior and Cover	Main Wire Size AWG/kcmil		Equipment Ground Bar Kit (Order Separately)	Box No.
				Cat. No. (DE3C)	Al	Cu	Cat. No. (DE3A)	
<b>Main Lugs—10 kA Short Circuit Current Rating</b>								
<b>Factory-installed Fixed Main Lugs, 10 kA Short Circuit Current Rating</b>								
70 A	2	4	2	HOM24L70RB <sup>(110)</sup>	12–3	14–4	PK4GTA	1R
100 A	6	12	6	HOM612L100RB <sup>(111)</sup>	8–1		PK7GTA	2R
125 A	4	8	4	HOM48L125GRB	12–2/0	14–2/0	PK7GTA Included	15R

**Table 44 - HOM Plug-on Neutral Load Center Main Lugs, Convertible Mains (1Ø3W–120/240 Vac Rainproof UL—Listed)**

Mains Rating	Spaces	Max. Single Pole Circuits	Max. Tandam Circuit Breakers	Load Center Box, Interior and Cover	Main Wire Size AWG/kcmil		Equipment Ground Bar Kit (Order Separately)	Box No.
				Cat. No. (DE3C)	Al	Cu	Cat. No. (DE3A)	
<b>Convertible Mains with Factory-installed Main Lugs <sup>(112)</sup>, QOM1 Main Frame Size—Convertible to Main Circuit Breaker</b>								
125 A	8	16	8	HOM816L125PRB	6–2/0	6–1	PK9-27GTA(L)	3R
	12	24	12	HOM1224L125PRB				4R
	20	40	20	HOM2040L125PRB				6R
	24	48	24	HOM2448L125PRB				
<b>Convertible Mains with Factory-installed Main Lugs <sup>(113)</sup>, QOM2 Main Frame Size—Convertible to Main Circuit Breaker</b>								
225 A	12	12	0	HOM12L225PRB	4–300	4–250	PK9-27GTA(L)	5R
	16	32	16	HOM1632L225PRB				6R
	20	40	20	HOM2040L225PRB				7R
	30	60	30	HOM3060L225PRB				14R
	40	80	40	HOM4080L225PRB				
	42	84	42	HOM4284L225PRB				

<sup>(109)</sup>Maximum single pole branch circuits utilizing HOM and/or HOMT circuit breakers.

<sup>(110)</sup>HOM-GFI and HOM-AFI branch circuit breakers are limited to number 10 maximum wire.

<sup>(111)</sup>70 A maximum branch circuit breaker, 100 A maximum back feed main circuit breaker.

<sup>(112)</sup>Side hinge door device allow 1-1/4 in. on left side for door to open.

<sup>(113)</sup>Convertible mains with factory-installed main lugs, QOM2 main frame size—convertible to main circuit breaker.

## Rainproof, HOM Convertible Mains (100–200 A) – Main Breaker



HOM2448M125PRB



HOM3060M200PRB

**Table 45 - HOM Plug-on Neutral Load Center Main Breaker, Convertible Mains (1Ø3W–120/240 Vac Rainproof – UL Listed)**

Mains Rating	Spaces	Max. Single Pole Circuits	Max. Tandam Circuit Breakers	Load Center Box, Interior and Cover	Main Wire Size AWG/kcmil		Equipment Ground Bar Kit (Order Separately)	Box No.
				Cat. No. (DE3C)	Al	Cu	Cat. No. (DE3A)	
<b>Main Circuit Breaker – 22 kA Short Circuit Current Rating Convertible Mains with Factory-Installed Main Circuit Breaker, QOM1 Main Frame Size – Convertible to Main Lugs or Lower Amperage Main Circuit Breaker <sup>(115)</sup></b>								
100 A	8	16	8	HOM816M100PRB	6–2/0	6–1	PK9-27GTA(L)	3R
	12	24	12	HOM1224M100PRB				4R
	20	40	20	HOM2040M100PRB				
125 A	8	16	8	HOM816M125PRB				3R
	24	48	24	HOM2448M125PRB				6R
<b>Convertible Mains with Factory-installed Main Circuit Breaker, QOM2 Main Frame Size – Convertible to Main Lugs or Lower Amperage Main Circuit Breaker</b>								
150 A	30	60	30	HOM3060M150PRB	4–250		PK9-27GTA(L)	7R
200 A	12	12	0	HOM12M200PRB				5R
	20	40	20	HOM2040M200PRB				6R
	30	60	30	HOM3060M200PRB				7R
	40	80	40	HOM4080M200PRB				14R
<b>Convertible Mains with Factory-installed Main Circuit Breaker with Feed-thru Lugs, QOM2 Main Frame Size – Convertible to Main Lugs or Lower Amperage Main Circuit Breaker <sup>(116)</sup></b>								
150 A	8	16	8	HOM816M150PFTRB	4–250		PK9-27GTA(L)	6R
200 A				HOM816M200PFTRB				

<sup>(114)</sup>Maximum single pole branch circuits utilizing HOM and/or HOMT circuit breakers.

<sup>(115)</sup>22 k AIR main circuit breaker UL Listed for use ahead of HOM and HOMT 10 k AIR branch circuit breakers to permit their application on systems with up to 22 kA available fault current.

<sup>(116)</sup>Side hinge door device allow 1-1/4 in. on left side for door to open.

# Homeline Label Samples



## Homeline Box Label Sample

<ul style="list-style-type: none"> <li>Number of circuits maximum</li> <li>Enclosure catalog number</li> <li>Catalog number of covers; flush or surface</li> <li>See load center interior for the catalog number</li> <li>Voltage ratings</li> <li>Amperage rating</li> </ul>	<p>Wire range for lug torque data table</p>	<p>Short circuit ratings</p>	<p>Short circuit ratings and additional or replacement circuit breakers</p>	<ul style="list-style-type: none"> <li>UL manifest</li> <li>Date code</li> <li>Plant code</li> <li>Label part number</li> <li>Manufacturer trademark</li> </ul>
---	---	------------------------------	---	---

<p><b>HOMELINE™ LOAD CENTER</b> See panelboard interior for Catalog No. Box / Caja - 5X1185 Cover / Cubierta - HOMC12UC Bus Bar Rating / Capacidad de Barra de conexión - 125A max. Circuit max. / Max. Circuitos - 16 Type 1 Enclosure / Gabinete Tipo 1</p> <p>Main max. / Max. Línea principal - 125A See main or service disconnect rating if installed. 240 V - Max., 1Ø, 50 / 60 Hz.</p>	<p><b>LUG TORQUE DATA</b> SEE CIRCUIT BREAKERS AND FIELD INSTALLED UNITS FOR WIRE RANGE AND TORQUE.</p> <table border="1"> <thead> <tr> <th>Lug type</th> <th>Wire Range (AWG/kcmil)</th> <th>Torque (lb-in)</th> </tr> </thead> <tbody> <tr> <td>Line Neutral Lug</td> <td>5-14, 12-20 AL</td> <td>45</td> </tr> <tr> <td>Main Lug</td> <td>5-14, 12-20 AL</td> <td>45</td> </tr> <tr> <td>Alternate</td> <td>See Main Breaker</td> <td>See Main Breaker</td> </tr> <tr> <td colspan="3"><b>BRANCH NEUTRAL, EQUIPMENT GROUNDING BAR &amp; SERVICE GROUND</b></td> </tr> <tr> <th>Terminal Type</th> <th>Wire Range (AWG)</th> <th>Torque (lb-in)</th> </tr> <tr> <td>Branch Neutral A</td> <td>4-6 Cu/AL</td> <td>35</td> </tr> <tr> <td>Equipment Ground Bar</td> <td>6-8 Cu/AL</td> <td>35</td> </tr> <tr> <td></td> <td>10-14 Cu, 12-14 AL</td> <td>35</td> </tr> <tr> <td></td> <td>13-14 Cu</td> <td>35</td> </tr> <tr> <td>Equipment Ground Connections</td> <td>10-12 Cu/AL</td> <td>35</td> </tr> <tr> <td></td> <td>13-14 AL</td> <td>35</td> </tr> </tbody> </table>	Lug type	Wire Range (AWG/kcmil)	Torque (lb-in)	Line Neutral Lug	5-14, 12-20 AL	45	Main Lug	5-14, 12-20 AL	45	Alternate	See Main Breaker	See Main Breaker	<b>BRANCH NEUTRAL, EQUIPMENT GROUNDING BAR &amp; SERVICE GROUND</b>			Terminal Type	Wire Range (AWG)	Torque (lb-in)	Branch Neutral A	4-6 Cu/AL	35	Equipment Ground Bar	6-8 Cu/AL	35		10-14 Cu, 12-14 AL	35		13-14 Cu	35	Equipment Ground Connections	10-12 Cu/AL	35		13-14 AL	35	<p><b>SHORT CIRCUIT CURRENT RATING</b></p> <table border="1"> <thead> <tr> <th>RMS Symmetrical Amperes x 1000 @ V - Max.</th> <th>Integral or Remote Main / Catalog Designation or Fuse Class (Max. A)</th> <th>Branch Circuit Breaker Catalog Designation (Max. A)</th> </tr> </thead> <tbody> <tr> <td>10 @ 240</td> <td>QOM VHT (125)</td> <td>HOM (100) †, HOMT, HOMP ‡</td> </tr> <tr> <td>22 @ 240</td> <td>QO-1H (125)</td> <td></td> </tr> <tr> <td>25 @ 240</td> <td>QO (125)</td> <td></td> </tr> <tr> <td>42 @ 240</td> <td>QOH</td> <td></td> </tr> <tr> <td>65 @ 240</td> <td>QO (125)</td> <td></td> </tr> <tr> <td>100 @ 240</td> <td>QJ (125)</td> <td></td> </tr> </tbody> </table> <p>† Includes suffixes: AFI, DF, EPD, and GFI. ‡ Includes suffixes: AFI and DF.</p>	RMS Symmetrical Amperes x 1000 @ V - Max.	Integral or Remote Main / Catalog Designation or Fuse Class (Max. A)	Branch Circuit Breaker Catalog Designation (Max. A)	10 @ 240	QOM VHT (125)	HOM (100) †, HOMT, HOMP ‡	22 @ 240	QO-1H (125)		25 @ 240	QO (125)		42 @ 240	QOH		65 @ 240	QO (125)		100 @ 240	QJ (125)		<p>See Circuit Breaker for voltage and Interrupting Rating. The rating is equal to the lowest Interrupting Rating of any Circuit Breaker installed. Refer to branch or main Circuit Breakers for individual ratings. Additional or Replacement Branch or Main Circuit Breaker, or Service Disconnect MUST have an Interrupting Rating equal to or greater than that of the Circuit Breaker with the lowest Interrupting Rating presently installed. See panelboard interior for Circuit Breaker types.</p> <p><b>UL CLASS CTL ENCLOSED PANELBOARD 8-9488</b></p> <p>For installation, repairs or alterations, call an electrical contractor or electrician. Maximum continuous loads not to exceed 80% of the ampere rating of any over current device installed. / Los cargas máximas continuas no deben exceder el 80% de la capacidad en amperaje de cualquier equipo de sobre corriente instalado.</p> <p><b>SQUARE D™</b> YYWVDS 15 EAV51738</p>
Lug type	Wire Range (AWG/kcmil)	Torque (lb-in)																																																										
Line Neutral Lug	5-14, 12-20 AL	45																																																										
Main Lug	5-14, 12-20 AL	45																																																										
Alternate	See Main Breaker	See Main Breaker																																																										
<b>BRANCH NEUTRAL, EQUIPMENT GROUNDING BAR &amp; SERVICE GROUND</b>																																																												
Terminal Type	Wire Range (AWG)	Torque (lb-in)																																																										
Branch Neutral A	4-6 Cu/AL	35																																																										
Equipment Ground Bar	6-8 Cu/AL	35																																																										
	10-14 Cu, 12-14 AL	35																																																										
	13-14 Cu	35																																																										
Equipment Ground Connections	10-12 Cu/AL	35																																																										
	13-14 AL	35																																																										
RMS Symmetrical Amperes x 1000 @ V - Max.	Integral or Remote Main / Catalog Designation or Fuse Class (Max. A)	Branch Circuit Breaker Catalog Designation (Max. A)																																																										
10 @ 240	QOM VHT (125)	HOM (100) †, HOMT, HOMP ‡																																																										
22 @ 240	QO-1H (125)																																																											
25 @ 240	QO (125)																																																											
42 @ 240	QOH																																																											
65 @ 240	QO (125)																																																											
100 @ 240	QJ (125)																																																											

## Homeline Wiring Diagram Sample

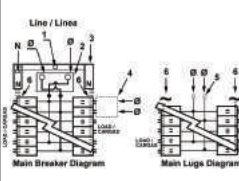
<p>Alternate wiring diagram for main circuit breaker or main lug</p>	<ul style="list-style-type: none"> <li>Service Equipment marking. Unused neutral branch terminal for equipment grounding, service equipment application only</li> <li>Installation of back-fed main circuit breaker and required kit</li> </ul>	<p>Load center accessories</p>	<p>Square D circuit breakers that may be used in this load center</p>
--	---	--------------------------------	---

<p>Suitable for use with 75°C Copper or Aluminum main conductors. See branch breakers for branch wire rating.</p> 	<ul style="list-style-type: none"> <li>Suitable for use as Service equipment when Service Disconnect (Main Breaker) is installed. Suitable for use as Service equipment when not more than six main disconnecting means are provided and when not used as a lighting and appliance branch circuit panelboard. See NEC, ANSI / NFPA 70. When used as Service equipment, all unused neutral terminals may be used for terminating equipment ground wires. When used as Service equipment install service entrance barrier Kit PKSB1LA for QOM1 Breakers. For back-fed main applications install HOM4RK2LA. Service entrance barrier does not allow the load center to be serviced energized.</li> </ul> <ol style="list-style-type: none"> <li>Box bonding when required. / Conexión a la caja cuando sea necesario.</li> <li>Main breaker type: / Interruptor automático principal tipo: QOM1 or QOM1A.</li> <li>Service ground when required. / Tierra de acometida cuando fuese necesario.</li> <li>For back-fed main applications install: / Para aplicaciones de dispositivos principales de alimentación inversa instale el kit: HOM4RK2LA.</li> <li>Main lugs kit no.: / No. de accesorio de las zapatas principales: QOL125.</li> <li>Extended neutrals shown are for plug on neutral ready interiors. / Los neutrals extendidos que se muestran son para interiores preparados con neutro enchufable.</li> </ol>	<p><b>Load Center Accessories - Kits</b></p> <p>HOM4RK2LA Back-fed Main Cir. Brkr. Retaining PKSB1LA Service Entrance Barrier HOM175SB Plug-On Surge Arrestor * SDSA1175 1 Phase Surge Arrestor HOM4RBSK1 Generator Interlock Kit QOSAMK SISA1175 Mounting Bracket HOM1L125 1 Phase Plug-on Subfeed Lugs * PKG125 Equipment Ground Bar PKG1AB Equipment Ground Bar Insulator LKG1AN Neutral Terminal Kit LK100AN 14-2 AWG Al/Cu wire Neutral Terminal Kit QOL125 6-20 AWG Al/Cu wire Main Lugs PKG1C Door Lock Kit QOL125VD 4/0 Lug Kit</p>	 <p>Two single poles, one plug on space or may use one single pole. One two pole requires two spaces.</p> <p>* May plug on two adjacent spaces. <b>Torque Note:</b> When interior mounting screws are loosened or removed, retighten to 35 lb-in. <b>Torque Note:</b> When main breaker or main lug connector mounting nuts are loosened or removed, retighten to 75 lb-in.</p> <p><b>Equipment Grounding Terminals</b> Assembled in US with US &amp; Foreign Parts QGH65716</p>
---	---	---	---

# Homeline Wiring Diagrams

## Homeline Load Centers – Main Lugs

**NOTE:** See each catalog number's associated technical drawing online for additional wiring diagram details.

**Figure 7 - Homeline Load Centers – Main Lugs**

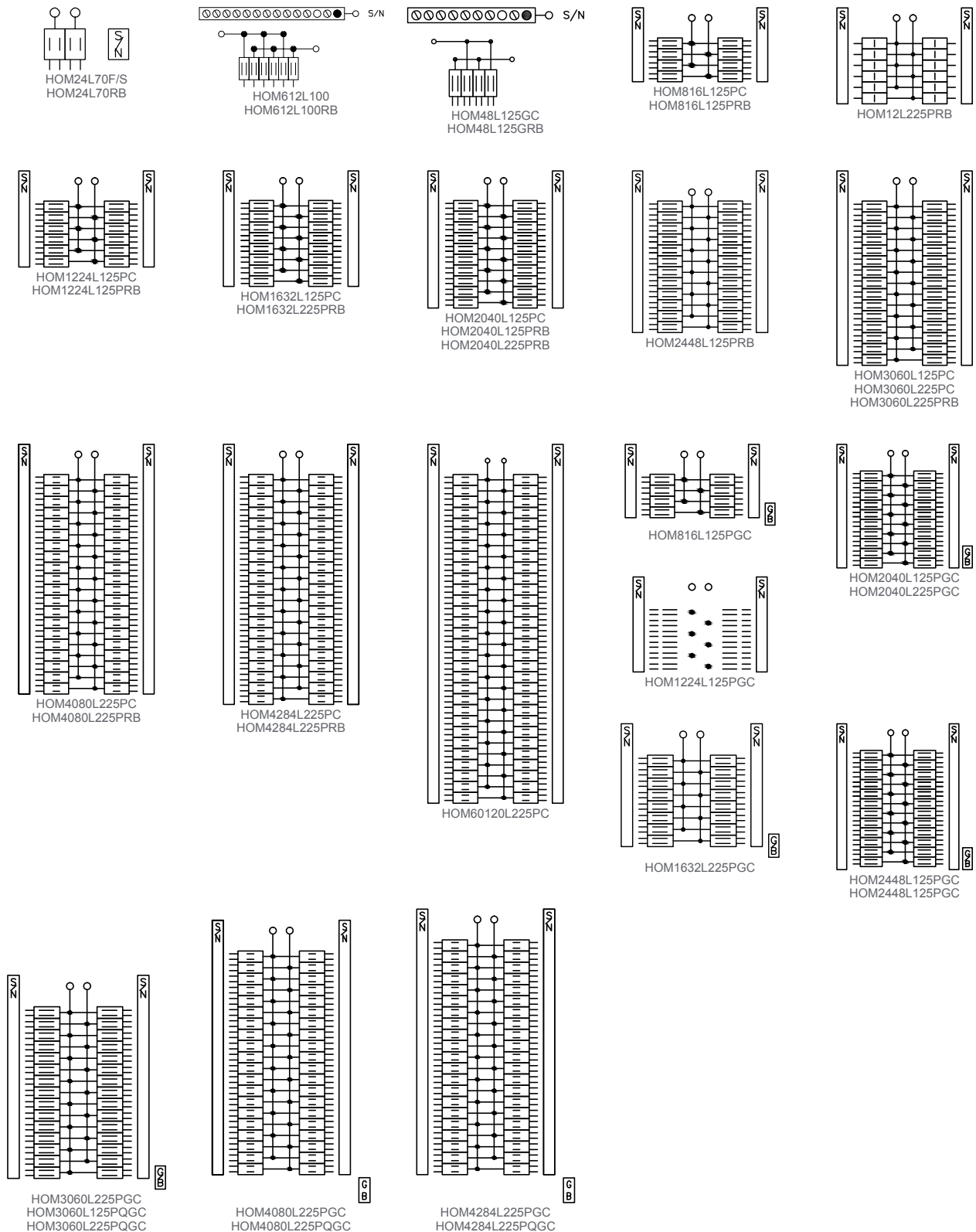

## Homeline Load Centers – Main Breaker

Figure 8 - Homeline Load Centers – Main Breaker

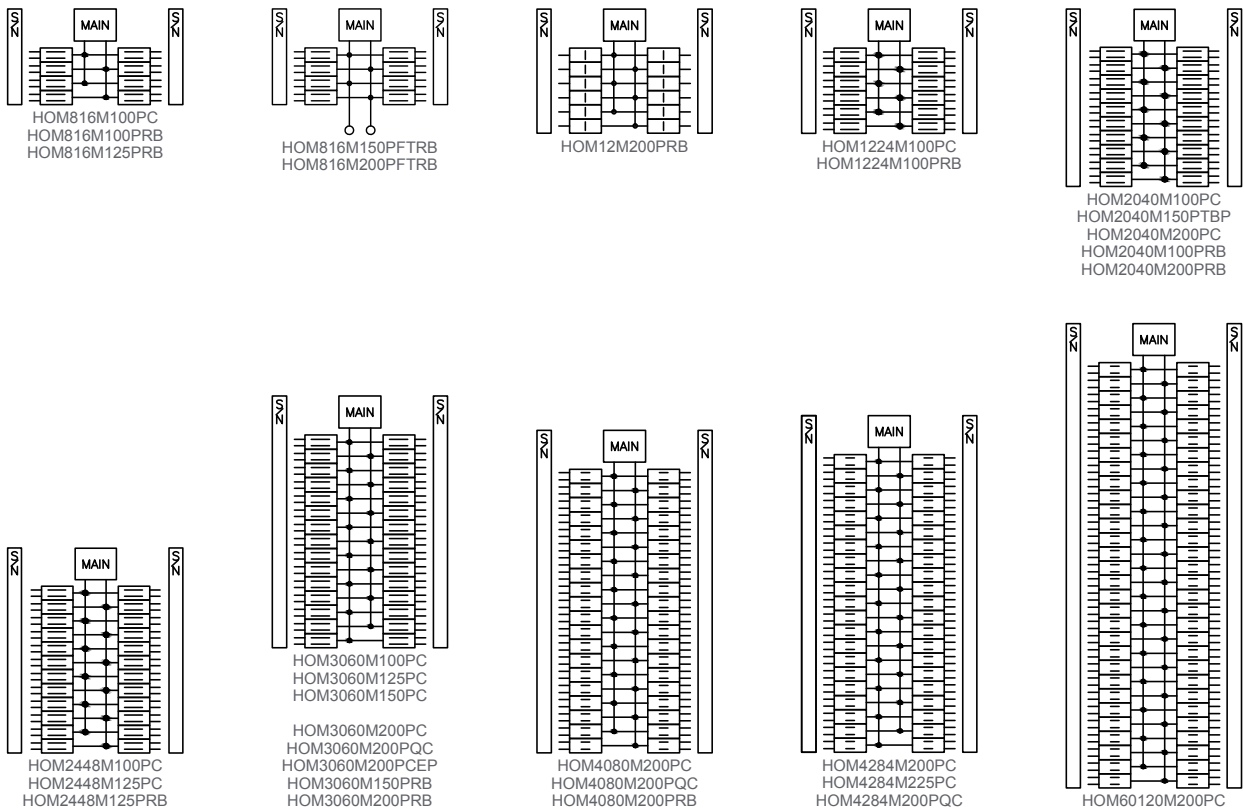

## Homeline Value Packs and Covers

### Value Pack Offer

Different value pack combinations offer an affordable mix of products for load center customers. Value packs are ideal for new construction, upgrades and remodels. Designed to meet various needs, special packs are combined for Homeline products.

### We've got you covered, the covers are included.

Indoor Homeline covers are available in gray or white colors; these can be purchased separately and limit loss or damage if stored at the job site.

Mono-Flat covers, a high-end alternative with aesthetically pleasing design and low profile surface with concealed mounting screws and door hinges, are an alternative to our standard covers.



## Plug-on Neutral Load Center Value Packs



HOM3060L225PGCVP



HOM2040M100PCVP

**Table 46 - Plug-on Neutral Indoor Load Center Value Packs (compatible with Plug-on Circuit Breakers and Plug-on Neutral Circuit Breakers)**

Mains Rating	Spaces	Max. 1P Circuits	Max. Tandem Circuit Breakers	Load Center Box, Interior, Cover and Branch Circuit Breakers		Equipment Ground Bar Kit (Order Separately)	Main Wire Size AWG/kcmil		Box No.
				Cat. No.	Included Load Center/ Circuit Breakers	Cat. No.	Al	Cu	
Homeline Convertible Mains—Factory-Installed Main Lugs (accepts only HOM Plug-On Circuit Breakers) 10 kA Short Circuit Current Rating Convertible to appropriate QOM 22 kA Short Circuit Current Rating Main Circuit Breaker									
125 A	12	24	12	HOM1224L125PGCVP	(1) HOM1224L125PGC (2) HOM120	PKGTALP1 Included	6-2/0	6-1	6
225 A	30	60	30	HOM3060L225PGCVP	(1) HOM3060L225PGC (3) HOM120 (2) HOM230	PKGTALP2 Included	4-300	4-250	10
100 A	20	40	20	HOM2040M100PCVP	(1) HOM2040M100PC (2) HOM120 (1) HOM230	PK9-27GTA(L) (Order Separately)	6-1	6-3	7
				HOM2040M100PC1AVP	(1) HOM2040M100PC (2) HOM120 (1) HOM230 (1) HOM115PCAFI				
	24	48	24	HOM2448M100PCVP	(1) HOM2448M100PC (3) HOM120 (2) HOM230		6-2/0	6-1/0	8

(117) Maximum single pole branch circuits utilizing QO and/or QOT (20 A MAX. NON-CTL) circuit breakers.  
 (118) See QO/Homeline Enclosure Dimensions and Knockout Information, page 67.

**Table 46 - Plug-on Neutral Indoor Load Center Value Packs (compatible with Plug-on Circuit Breakers and Plug-on Neutral Circuit Breakers) (Continued)**

Mains Rating	Spaces	Max. 1P Circuits	Max. Tandem Circuit Breakers	Load Center Box, Interior, Cover and Branch Circuit Breakers		Equipment Ground Bar Kit (Order Separately)	Main Wire Size AWG/kcmil		Box No.
				Cat. No.	Included Load Center/ Circuit Breakers		Cat. No.	Al	
150 A	30	30	30	HOM3060M150PCVP	(1) HOM3060M150PC (3) HOM120 (2) HOM230	PK9-27GTA(L) (Order Separately)	4-250		10
	20	40	20	HOM2040M200PCVP	(1) HOM2040M200PC (3) HOM120 (2) HOM230				9
	30	60	30	HOM3060M200PCVP	(1) HOM3060M200PC (3) HOM120 (2) HOM230				10
				HOM3060M200PC1AVP	(1) HOM3060M200PC (3) HOM120 (2) HOM230 (1) HOM115PCAFI				
200 A	30	60	30	HOM3060M200PCAFVP	(1) HOM3060M200PC (3) HOM120 (2) HOM230 (3) HOM115PCAFI	PK9-27GTA(L) (Order Separately)	4-250		12
	40	80	40	HOM4080M200PCVP	(1) HOM4080M200PC (3) HOM120 (2) HOM230				
				HOM4080M200PC1AVP	(1) HOM4080M200PC (3) HOM120 (2) HOM230 (1) HOM115PCAFI				
				HOM4080M200PCAFVP	(1) HOM4080M200PC (3) HOM120 (2) HOM230 (3) HOM115PCAFI				

**Table 47 - Plug-on Neutral with Qwik-Grip Indoor Load Center Value Packs — (compatible with Plug-on Circuit Breakers and Plug-on Neutral Circuit Breakers)**

Mains Rating	Spaces	Max. 1P Circuits	Max. Tandem Circuit Breakers	Load Center Box, Interior, Cover and Branch Circuit Breakers		Equipment Ground Bar Kit (Order Separately)	Main Wire Size AWG/kcmil		Box No.
				Cat. No.	Included Load Center/ Circuit Breakers		Cat. No.	Al	
<b>Homeline Convertible Mains—Factory-Installed Main Circuit breaker, 22 kA Short Circuit Current Rating—Copper Bus, QOM1 Main Frame Size, Convertible to Main Lugs or Main Breaker</b>									
100 A	20	40	20	HOM2040M100PQCV	(1) HOM2040M100PQC (2) HOM120 (1) HOM230 and (1) PKQGA Qwik-Grip assembly kit	PK9-27GTA(L)	6-1	6-3	7Q
200 A	30	60	30	HOM3060M200PQCV	(1) HOM3060M200PQC (3) HOM120 (2) HOM230 and (1) PKQGA Qwik-Grip assembly kit		4-250		10Q

(119) Maximum single pole branch circuits utilizing QO and/or QOT (20 A MAX. NON-CTL) circuit breakers.  
 (120) See QO/Homeline Enclosure Dimensions and Knockout Information, page 67.

**Table 47 - Plug-on Neutral with Qwik-Grip Indoor Load Center Value Packs — (compatible with Plug-on Circuit Breakers and Plug-on Neutral Circuit Breakers) (Continued)**

Mains Rating	Spaces	Max. 1P Circuits	Max. Tandem Circuit Breakers	Load Center Box, Interior, Cover and Branch Circuit Breakers		Equipment Ground Bar Kit (Order Separately)	Main Wire Size AWG/kcmil		Box No.
				Cat. No.	Included Load Center/Circuit Breakers		Cat. No.	Al	
200 A	40	80	40	HOM4080M200PQCVP	(1) HOM4080M200PQC (2) HOM120 (1) HOM230 and (1) PKQGA Qwik-Grip assembly kit		4-250		12Q

**Table 48 - Plug-on Neutral Rainproof Load Center Value Packs (compatible with Plug-on Circuit Breakers and Plug-on Neutral Circuit Breakers)**

Mains Rating	Spaces	Max. 1P Circuits	Max. Tandem Circuit Breakers	Load Center Box, Interior, Cover and Branch Circuit Breakers		Equipment Ground Bar Kit (Order Separately)	Main Wire Size AWG/kcmil		Box No.
				Cat. No.	Included Load Center/Circuit Breakers		Cat. No.	Al	
<b>Homeline (Accepts Only HOM Plug-On Circuit Breakers) Convertible Mains—Factory-Installed Main Circuit Breaker, 22 kA Short Circuit Current Rating Convertible to Main Lugs or Lower Amperage QOM2 Main Circuit Breaker</b>									
125 A	12	24	12	HOM1224M125PRBVP	(1) HOM1224M125PRB (3) HOM120 (2) HOM230	PK9-27GTA(L)	6-2/0	6-1	3R
200 A	30	60	30	HOM3060M200PRBVP	(1) HOM3060M200PRB (3) HOM120 (2) HOM230		4-250		7R

**Table 49 - Plug-on Neutral Load Center Value Packs with Surge Protective Device (compatible with Plug-on Circuit Breakers and Plug-on Neutral Circuit Breakers)**

Mains Rating	Spaces	Max. 1P Circuits	Max. Tandem Circuit Breakers	Load Center Box, Interior, Cover and Branch Circuit Breakers		Equipment Ground Bars	Main Wire Size AWG/kcmil		Box No.
				Cat. No.	Included Load Center/Circuit Breakers/SPD		Cat. No.	Al	
225 A	30	60	30	HOM3060L225PGCSVP2	(1) HOM3060I225PGC (1) HOM230 (2) HOM120, (1) Plug-on Neutral HOM250PSPD, Cover and Ground Bar	PKGTALP2 Included	4-300	4-250	10
200 A	8	16	8	HOM816M200PFTRBSP2	(1) HOM816M200PFTRB (1) Plug-on Neutral HOM250PSPD	PK15GTA (Order Separately)	4-250		6R

(121) See QO/Homeline Enclosure Dimensions and Knockout Information, page 67.

## Homeline Load Center Covers



HOMC12UCW



HOMC24UC

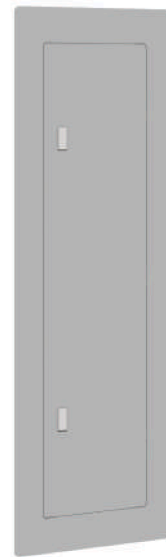

HOMCMF60UC

**Table 50 - Homeline Load Center Covers**



Mains Rating	Spaces	Homeline Standard Covers		Homeline Mono Flat Covers
		Combination	Combination	Gray
		Gray	White	
100 A	8	HOMC8UC	—	—
	12	HOMC12UC	HOMC12UCW	—
	24	HOMC24UC	HOMC24UCW	—
125 A	8	HOMC12UC	HOMC12UCW	—
	12	HOMC12UC	HOMC12UCW	—
	16	HOMC24UC	HOMC24UCW	—
	20	HOMC24UC	HOMC24UCW	—
	24	HOMC24UC	HOMC24UCW	—
150 A	16	HOMC20UC	HOMC20UCW	—
	20	HOMC20UC	HOMC20UCW	—
	30	HOMC30UC	HOMC30UCW	—
200 A	12	HOMC20UC	HOMC20UCW	—
	16	HOMC20UC	HOMC20UCW	—
	20	HOMC20UC	HOMC20UCW	—
	30	HOMC30UC <sup>(121)</sup>	HOMC30UCW	—
	40	HOMC42UC	—	—
	42	HOMC42UC	—	—
	60	HOMC60UC	—	HOMCMF60UC
225 A	16	HOMC20UC	HOMC20UCW	—
	20	HOMC20UC	HOMC20UCW	—
	30	HOMC30UC	HOMC30UCW	—
	40	HOMC42UC	—	—
	42	HOMC42UC	—	—
	60	HOMC60UC	—	HOMCMF60UC

<sup>(121)</sup>Extra long version available HOMC30UFL.

# QO/Homeline Load Centers

## QO vs. Homeline Load Centers

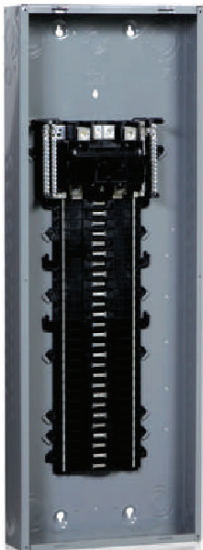
Table 51 - QO vs. Homeline Load Centers

QO Load Centers		Homeline Load Centers	
	QO 3/4 in. breakers feature Visi-Trip trip to center position	<b>UL Listed Only for Square D Circuit Breakers</b>	Homeline 1 in. circuit breakers trip to center position
	PON circuit breakers installed on any space in select Load Centers	<b>Accepts Plug-on Neutral CAFIs</b>	PON circuit breakers installed on any space
	Top and split neutral plus (2 or 3) #1 AWG terminals	<b>Backed-out Neutral Terminal Screws</b>	Fully distributed split neutral
	Tin-plated copper	<b>Bus Bars</b>	Tin and copper plated aluminum
	Shielded	<b>Bus Bars</b>	Not shielded
	3/4 in. per 1 Pole space 40 spaces/circuit = 33 3/4 in. Tall Enclosure	<b>Circuit Breaker Format</b>	1 in. per 1 Pole space 40 space/circuit = 39 1/2 in. Tall Enclosure
	Option for Surface or Flush covers that ship separately, or a combo cover (in carton) shipped with Load Center	<b>Cover Options</b>	Combo cover (in carton) shipped with Load Center
	Lifetime Limited	<b>Warranty</b>	Combo cover (in carton) shipped with Load Center
			

## QO/Homeline Enclosure Dimensions and Knockout Information

### Indoor Load Centers

Table 52 - Enclosure Dimensions for Indoor Load Centers

Box No.	W		H		D		Box No.	W		H		D	
	in.	mm	in.	mm	in.	mm		in.	mm	in.	mm	in.	mm
1	3.81	97	6.72	171	3.00	76	14	14.25	362	20.92	531	3.75	95
2	4.81	122	9.30	236	3.19	81	15	20.00	508	50.00	1270	5.75	146
3	4.81	122	9.30	236	3.19	81	16	20.00	508	62.00	1730	5.75	146
4	8.88	226	12.57	319	3.80	97	17	20.00	508	53.00	1350	5.75	146
5	14.25	362	14.92	379	3.75	95	18	5.88	149	16.12	409	3.38	86
6	14.25	362	17.92	455	3.75	95	19	7.56	192	23.12	587	4.25	108
7	14.25	362	20.92	531	3.75	95	20	9.62	244	26.12	663	4.75	121
8	14.25	362	26.04	661	3.75	95	21	8.88	226	14.80	376	3.80	97
9	14.25	362	29.86	758	3.75	95	22	8.55	217	23.92	608	3.95	100
10	14.25	362	33.78	858	3.75	95	23	14.25	362	29.86	758	3.75	95
11	14.25	362	37.98	965	3.75	95	24	14.25	362	43.15	1100	3.75	95
12	14.25	362	39.37	1000	3.75	95	25	14.25	362	48.5	1240	3.75	95
13	5.88	149	13.12	333	3.38	86	26	14.25	362	33.78	858	3.75	95

**Table 53 - Knockouts for Indoor Load Centers**

Symbol	A	B	C	D	E	F	G	H	I
Conduit Size	1/2	3/4	1	1 1/4	1 1/2	2	2 1/2	3	3 1/2

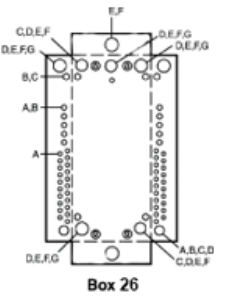
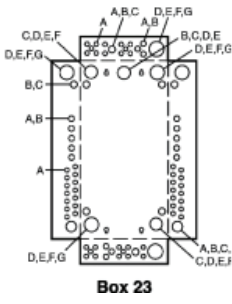
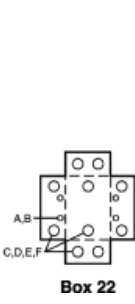
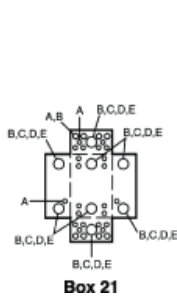
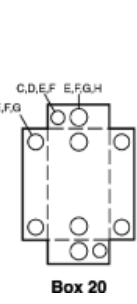
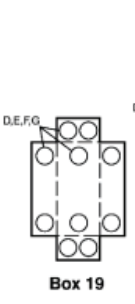
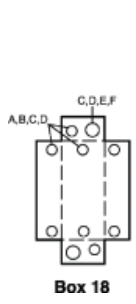
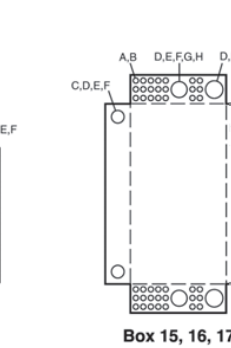
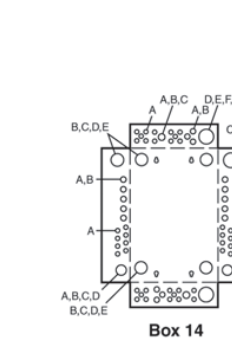
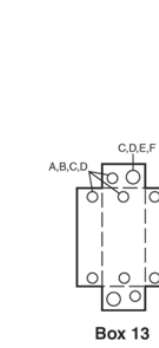
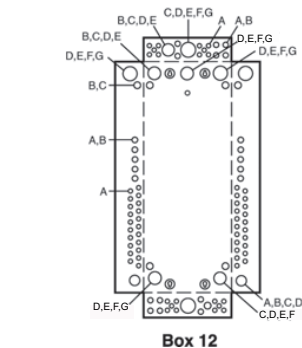
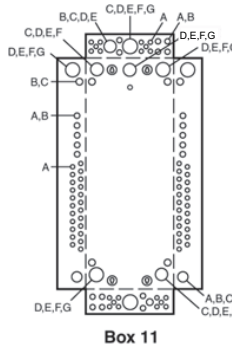
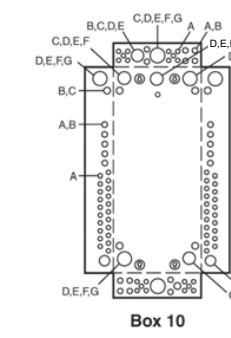
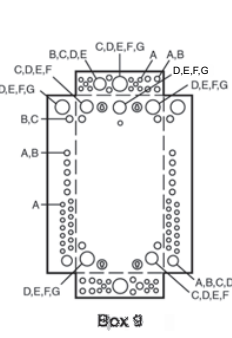
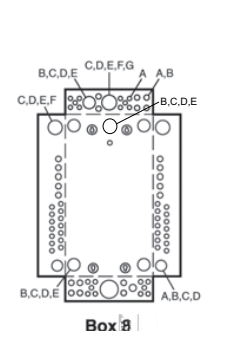
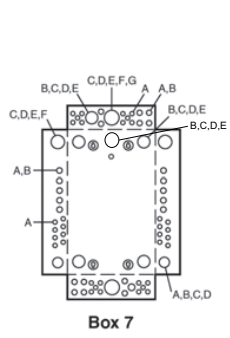
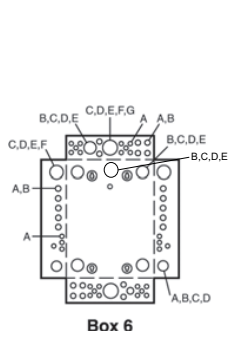
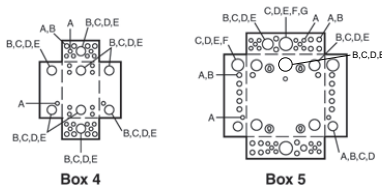
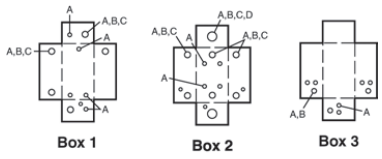

## Indoor Load Centers with Qwik-Grip

**Table 54 - Enclosure Dimensions for Indoor Load Centers with Qwik-Grip**

Box No.	W		H		D	
	in.	mm	in.	mm	in.	mm
7Q	14.25	362	20.92	531	3.75	95
8Q			26.04	661		
9Q			29.86	758		
10Q			33.78	858		
11Q			37.98	965		
12Q			39.37	1000		

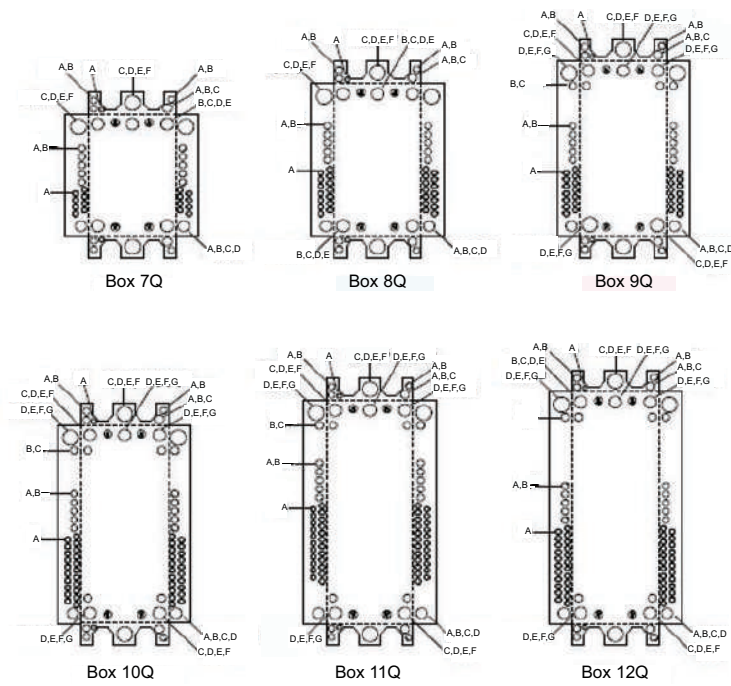

## Rainproof Load Centers

**Table 55 - Enclosure Dimensions for Rainproof Load Centers**

Box No.	W		H		D	
	in.	mm	in.	mm	in.	mm
1NM	6.52	166	8.79	223	3.90	99
1R <sup>(122)</sup>	4.88	124	9.38	238	4.00	102
2R	8.88	226	12.65	321	4.27	108
3R	14.75	375	18.92	481	4.52	115
4R			22.06	560		
5R			26.04	661		
6R			29.86	758		
7R			33.78	858		
8R			37.98	965		
9R	4.56	116	6.50	165	3.88	99
10R	6.92	176	13.18	335	4.12	105
11R	7.56	192	23.24	590	4.75	121
12R	9.62	244	26.24	666	5.50	140
13R	6.92	176	16.18	411	4.12	105
14R	14.75	375	39.37	1000	4.52	115
15R	8.88	226	14.8	376	4.27	108
16R	8.55	217	24.75	629	4.16	106
17R	8.88	226	12.65	321	4.27	108

**Table 56 - Knockouts for Rainproof Load Centers**

Symbol	A	B	C	D	E	F	G	H
Conduit Size	1/2	3/4	1	1 1/4	1 1/2	2	2 1/2	3

<sup>(122)</sup>HOME250SPA and QO260NATR top endwall has no hub opening.

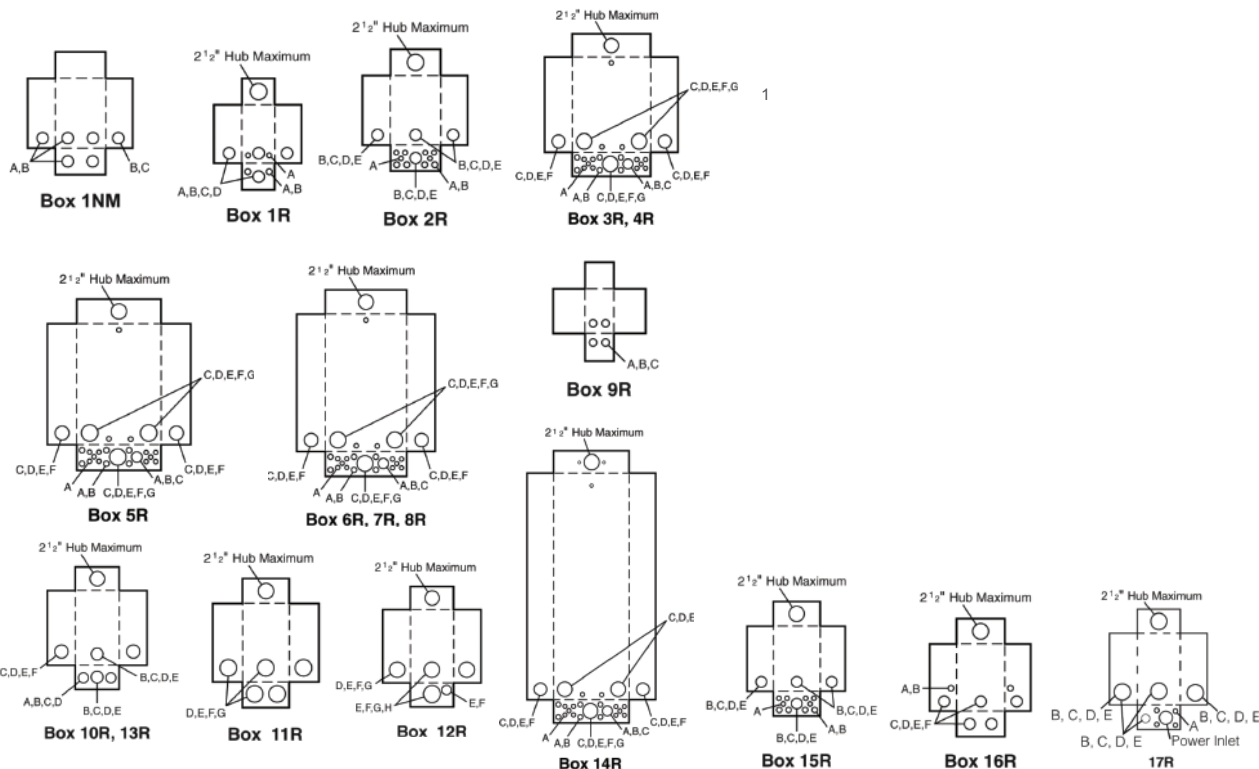

[35] HOME250SPA and QQ260NATR top endwall has no hub opening.

## QO/Homeline Bolt-On Hubs

Square D equipment with R or RB suffix, designated NEMA 3R rainproof construction, utilizes bolts-on hubs listed below. The RB devices will accept 3/4 in. through 2 1/2 in. bolt-on hubs without the use of reducers.

Off-center conduit thread openings and elongated mounting holes provide quick and easy adjustment to eliminate costly conduit offsets and bends. Catalog devices with suffix R require 3 in. through 4 in. field cut opening. Hubs are suitable for use with conduit having ANSI standard taper pipe thread.



B075



B150



B250

**Table 57 - UL Listed Bolt-On Hubs for RB Devices**

Hub Cat. No.	B075	B100	B125	B150	B200	B250
Conduit Size	3/4 in.	1 in.	1-1/4 in.	1-1/2 in.	2 in.	2-1/2 in.

**NOTE:** Closing cap (catalog number B-CAP) is provided factory-installed on each device with the RB suffix.

**Table 58 - UL Listed Enclosure Coupling for RB Devices**

(Designed for mounting in field cut opening. Includes gasket and four mounting bolts and nuts.)		
Hub Cat. No.	B300	B400
Conduit Size	3 in.	4 in.

## QO/Homeline Accessories



PSDS

**Table 59 - Circuit Identification Stickers**

Load Center	Cat. No.	Usage Information
QO and Homeline	PSDS	Circuit identification stickers for use on cover directory labels to identify branch circuits



QO1SE

**Table 60 - Cover Sealing Strap**

Load Center	Cat. No.	Usage Information
QO	QO1SE	Provides means of sealing trim mounting screws on QO load center covers



PK8FL

**Table 61 - Door Lock Kits**

(Available for indoor load centers. Two keys provided with each lock kit.)

Load Center	Cat. No.	Usage Information
QO	PK8FL <sup>(123)</sup>	Use with QO612L100DF/S, QO612L100DFCU/SCU, QO612L100DTF/S, QO816L100DF/S, QO816L100DFCU/SCU, QO816L100DTF/S, QO48M30DSGP, or QO48M60DSGP
QO and Homeline	PK6FL	Use with convertible mains, 1Ø and 3Ø 100–225 A, and fixed mains, 3Ø 125–225 A indoor load centers
QO	PK4FL	Use with 300 and 400 A indoor load centers



PK6FL



PK4FL

**Table 62 - Filler Plates**

(Fast to install, snap-in type)

Load Center	Cat. No.	Usage Information
QO	QOFP	Use on QO load center cover to fill unused branch circuit breaker opening
QO and Homeline	QOM1FP	Fills main circuit breaker opening in convertible load center covers 100–125 A
	QOM2FP	Fills main circuit breaker opening in convertible load center covers 150–225 A
QO	QO2FP	Fills main circuit breaker opening in Q style 3Ø load center covers (S03 Series)
Homeline	HOMFP	Use on Homeline load center cover to fill unused branch circuit breaker opening



QOFP



QO2P



HOMFP

<sup>(123)</sup>QO403L60NF/S does not have provisions for a field-installed lock.

**Table 63 - Handle Padlock Attachments**



QOM1PA



QOM2PA

Load Center	Cat. No.	Usage Information
QO and Homeline	QOM1PA	For padlocking main circuit breakers in convertible load center OFF
	QOM2PA	For padlocking main circuit breakers in convertible load center OFF

**Table 64 - Neutral Bonding Screw**



4028344850K



4028345850K

Load Center	Cat. No.	Usage Information
QO and Homeline	4028344850K	For use on all Homeline and QO 125 convertible main load centers
	4028345850K	For use on QO 150–225 convertible main load centers
	PKNBSCP	For use on QO and Homeline convertible main load centers

**Table 65 - Neutral / Ground Lugs**



LK70AN



LK225AN

Load Center	Cat. No.	Usage Information
QO and Homeline	LK70AN	Field-installed for 12–2 Al or 14–4 Cu AWG wire
	LK100AN	Field-installed for 6–2/0 Al/Cu AWG wire
	LK125AN	Field-installed for 14–2/0 Al/Cu AWG wire
QO	LK150AN	Field-installed for 2–3/0 Al/Cu AWG wire
	LK225AN	Field-installed for 4 AWG to 300 kcmil Al/Cu wire. Use in Series S, 150-225 A QO load center.

**Table 66 - Replacement Cover Directory Label**



UCD42CP

Load Center	Cat. No.	Usage Information
QO and Homeline	LSDL	1 through 42 numbered universal replacement directory label for load center covers
	UCD42CP	1 through 42 universal circuit directory kit, including circuit identification labels

**Table 67 - Retaining Kit for Breakers Used as Backfed Mains**



Load Center	Cat. No.	Usage Information
(Back-fed main circuit breaker retaining kits secure 2-pole, 10-125 A circuit breakers to single-phase or three-phase mains interiors when used as back-fed main circuit breakers. Mounting of retaining kits is based on top-feed applications.)		
QO	PK2MB	Fasten circuit breaker to interior when used as a back-fed main. For QO612L100F/S, RB, QO612L100DF/S, QO816L100F/S, RB, QO816L100DF/S and QO148L125GF/S, GRB load centers.
	PK3MB	Fasten 3P circuit breaker without accessories to left side of interior when used as a back-fed main. For 3Ø load centers.
	PK5RK	Fasten circuit breaker to interior when used as a back-fed main for 2P QO 150–200 A circuit breakers.
	PK4MB2LA	Fasten one circuit breaker with or without electrical accessories to right side of interior when used as a back-fed main. For 1Ø 100–125 ampere convertible main load centers. Series S01 and S02
	PK4MB2HA	Fasten one circuit breaker with or without electrical accessories to right side of interior when used as a back-fed main. For 1Ø 150–225 ampere convertible main load centers. Series S01 and S02
Homeline	HOM1RK	Fasten circuit breaker to interior when used as a back-fed main. For HOM612L100F/S, RB and HOM48L125GC, GRB load centers.
	HOM4RK2LA	Fasten one circuit breaker right side of interior when used as a back-fed main. For 100–125 A convertible main load centers, Series S01 and S02
	HOM4RK2HA	Fasten one circuit breaker right side of interior when used as a back-fed main. For 150–225 A convertible main load centers, Series S01 and S02
	HOM5RK	Fasten circuit breaker to interior when used as a back-fed main. For 2P 150–200 A circuit breakers.

**Table 68 - Service Entrance Barriers**

Load Center	Cat. No.	Usage Information
QO and Homeline	PKSB1LA	QO / Homeline 1Ø 100–125 A QOM1 convertible main load centers
	PKSB1HA	QO / Homeline 1Ø 150–225 A QOM2 convertible main load centers
QO	PKSB3	QO 3Ø convertible main load centers
	PKSB1QOBF	QO 1Ø back-fed main breaker applications
	PKSB3BF	QO 3Ø back-fed main breaker applications
	PKSB1QO2	QO enclosed circuit breaker devices
Homeline	PKSB1HOMBF	Homeline back-fed main breaker applications
	PKSB1FM	HOM24L fixed main load centers

**Table 69 - Generator Circuit Breaker Interlock Kit**



QOCRBGK1C



QOCGK2C



QORBGK2C



HOMCGK2C



HOMRBGK2C

Load Center	Cat. No.	Usage Information
QO	QOCRBGK1C	For use on G and S Series NEMA 1 and G, S1 and S2 Series NEMA 3R load centers. Interlocks a QOM1 2P main circuit breaker of a load center (100–125 A) with a QO 2P (15–125 A) branch circuit breaker. Includes a retaining kit.
	QOCGK2C	For use on G and S Series NEMA 1 and G and S1 Series NEMA 3R load centers. Interlocks a QOM2 2P main circuit breaker of a load center (150–225 A) with a QO 2P (15–125 A) branch circuit breaker. Includes a retaining kit.
	QORBGK2C	For use on S2 Series NEMA 3R load centers. Interlocks a QOM2 2P main circuit breaker of a load center (150–225 A) with a QO 2P (15–125 A) branch circuit breaker. Includes a retaining kit.
Homeline	HOMCRBGK1C	For use on S Series NEMA 1 and NEMA 3R load centers. Interlocks a QOM1 2P main circuit breaker of a load center (100–125 A) with a Homeline 2P (15–125 A) branch circuit breaker.
	HOMCGK2C	For use on S Series NEMA 1 and S1 Series NEMA 3R load centers. Interlocks a QOM2 2P main circuit breaker of a load center (150–225 A) with a Homeline 2P (15–125 A) branch circuit breaker.
	HOMRBGK2C	For use on S2 and S3 Series NEMA 3R QOM2 load centers. Interlocks a QOM2 2P main circuit breaker of a load center (150–225 A) with a Homeline 2P (15–125 A) branch circuit breaker.

**Table 70 - Qwik-Grip Load Center Accessories**



PKQGFP



PKQGI

Load Center	Cat. No.	Usage Information	Qty.
QO and Homeline	PKQGS	Qwik-Grip replacement shield — Qwik-Grip shield	1
	PKQGFP	Qwik-Grip fillers — Qwik-Grip fillers	10
	PKQGI	Qwik-Grip replacement insert — Qwik-Grip insert	1
	PKQGA	Qwik-Grip assembly kit — Qwik-Grip shields, Qwik-Grip fillers	4 each

**Table 71 - Manual Transfer Equipment Kit**



QO2DTI



QODTIM



PK4DTIM4LA



PK4DTIM4LAL



PK7GTA



PK12GTA



PK15GTA6



PKGTALP1



PKGTAB

(Manual transfer equipment kits secure two 2-pole, 10-125 A circuit breakers.)		
Load Center	Load Center	Usage Information
QO	QO2DTI	For interlocking the handles of two 2P or one 2P and one 1P QO and Q1 circuit breakers mounted side-by-side so that only one circuit breaker can be ON at a time.
	QODTIM	QO2DTI mechanical interlock attachment with retaining kits for securing two adjacent back-fed circuit breakers in dual power supply applications. Can be used with (2) 2P or (1) 2P and (1) 1P QO circuit breakers in QO816L100 load centers.
	PK4DTIM4LA	Secures two 2P circuit breakers to right side of interior when used as back-fed mains, a QO2DTI Kit included for back-up power supply applications. For 1Ø 100–125 ampere convertible main load centers. Series S01 and S02.
	PK4DTIM4LAL	Secures two 2P circuit breakers to left side of interior when used as back-fed mains, a QO2DTI Kit included for back-up power supply applications. For 1Ø 100–125 ampere convertible main load centers. Series S01 and S02.

**Table 72 - Ground Bar Kits**

(Field-installable in all load centers. Same wire size as neutral terminals. Suitable for copper or aluminum wire)		
Load Center	Load Center	Usage Information
QO and Homeline	PK3GTA1	Ground Bar Assembly—3 connectors
	PK4GTA	Ground Bar Assembly—4 connectors
	PK5GTA	Ground Bar Assembly—5 connectors
	PK7GTA	Ground Bar Assembly—7 connectors
	PK9GTA	Ground Bar Assembly—9 connectors
QO	PK12GTA	Ground Bar Assembly—12 connectors
QO and Homeline	PK15GTA	Ground Bar Assembly—15 connectors
	PK18GTA	Ground Bar Assembly—18 connectors
	PK23GTA	Ground Bar Assembly—23 connectors
	PK27GTA	Ground Bar Assembly—27 connectors
QO	PK15GTA6	Ground Bar Assembly—21 connectors. Use in high amperage load centers
	PK15GTAL	Standard PK15GTA with a 1–4/0 Al/Cu Lug
QO and Homeline	PK18GTAL	Standard PK18GTA with a 1–4/0 Al/Cu Lug
QO	PK23GTAL	Standard PK23GTA with a 1–4/0 Al/Cu Lug
QO and Homeline	PKGTALP1	Ground Bar Pack— PK9GTA, PK9GTA, and LK100AN
	PKGTALP2	Ground Bar Pack— PK9GTA, PK18GTA, and LK100AN
	PKGTALP3	Ground Bar Pack—PK15GTA, PK18GTA, and LK100AN
	PKGTAB	Insulator Kit for PK7GTA through PK27GTA



**Table 73 - Ground Bar Kits**

(All PK equipment grounding kits are supplied with mounting screws, necessary installation instructions, and an equipment grounding terminal self-adhesive label.)												
Catalog No.	Total Qty.	Terminals						Approximate Overall Length		Distance Between Mounting Holes		Mounting
		Quantity Each Size (See <a href="#">Wiring Range</a> , page 77)										
		I	II	III	IV	V	VI	in.	mm	in.	mm	
PK3GTA1	3	3	—	—	—	—	—	1.38	35	One hole	One hole	Top
PK4GTA	4	4	—	—	—	—	—	1.63	41	One hole	One hole	Top
PK5GTA	5	5	—	—	—	—	—	2.25	57	1.25	32	Top
PK7GTA	7	7	—	—	—	—	—	2.88	73	1.25	32	Top or Side
PK9GTA	9	9	—	—	—	—	—	3.78	96	3.13	80	Top
PK12GTA	12	12	—	—	—	—	—	4.7	119	3.13	80	Top
PK15GTA	15	15	—	—	—	—	—	5.63	143	3.13	80	Top
PK15GTAL	16	15	1	—	—	—	—	8.13	207	3.13	80	Top
PK15GTA6	21	15	—	—	6	—	—	5.88	149	(124)	(124)	Top
PK18GTA	18	18	—	—	—	—	—	8.13	167	3.13	80	Top
PK18GTAL	19	18	1	—	—	—	—	5.88	224	3.13	80	Top
PK23GTA	23	23	—	—	—	—	—	6.56	206	3.13	80	Top
PK23GTAL	24	23	1	—	—	—	—	8.81	240	3.13	80	Top
PK27GTA (125)	27 or 26	27 or 26	—	1	—	—	—	8.11	238	3.13	80	Top

**Table 74 - Wiring Range**

Size	Cu (AWG)	Al (AWG)
I	(1) #14 – # 4 or (2) #14 or #12	(1) #12 – #4 or (2) #12 or #10
II	(1) #1 – 4/ 0	(1) #1 – 4/0
III	(1) #6 – 2/ 0	(1) #6 – 2/0
IV	(1) #6 – 3/0	(1) #6 – 3/0
V	(1) #14 – 1/0	(1) #14 – 1/0
VI	(1) #10 – 2/0	(1) #6 – 2/0

(124)3.13 in. (80 mm) on small terminals; 5.25 in. (133 mm) on large terminals.

(125)PK27GTA includes one main grounding lug that mounts with two terminal screws and requires three terminals for mounting.

## QO/Homeline Surge Protective Devices (SPD)

Square D Whole Home Surge Protection blocks the voltage spikes at the load center, providing downstream protection for all your connected devices. Square D Surge Protective Devices have been developed based on decades of expertise and industry-leading technology, making it a trusted brand among homeowners and electrical contractors alike.

To decide which device is best for your home, consider the following sections when working with your electrical contractor.

### Load Center and CSED Surge Protective Devices

Cat. No.	Description	Surge Current per Phase	Schedule
<b>1 phase – 3 wire</b>			
QO2175SB	QO Surgebreaker	22.5 kA	DE1B
HOM2175SB	HOM Surgebreaker		
SDSA1175	1Ø3W–120/240 V Compact SPD	36 kA	
QO250PSPD	QO Plug-on Neutral SPD	50 kA	
HOM250PSPD	HOM Plug-on Neutral SPD	50 kA	
HEPD25	SurgeArrest Whole Home Electronic Protection	25 kA	
HEPD50		50 kA	
HEPD80		80 kA	
SDSB80111	Surgebreaker Plus (all-in-one protection for appliances, ethernet, and telephone)	80 kA	
<b>3 phase – 3 wire</b>			
SDSA2040D	3Ø3W–240 V Compact SPD	40 kA	DE1B
<b>3 phase – 4 wire</b>			
SDSA2040	3Ø4W–208Y/120 V Compact SPD	40 kA	DE1B

## Load Center and CSED Surge Protective Devices Mounting Kits



QOSAMK



HEPD58MKF

Cat. No.	Description	Surge Current per Phase	Schedule
QOSAMK	SDSA1175 Mount Kit	—	DE1B
HEPD25MKF	HEPD25 Flush Mount Kit	—	
HEPD58MKF	HEPD50 and HEPD80 Flush Mount Kit	—	

## Whole Home Surge Protection



QO250PSPD



HOM250PSPD



SDSA1175

### Plug-on Neutral SPD for QO (QO250PSPD) and Homeline (HOM250PSPD)

**Use** — QO250PSPD for QO load centers, combination devices (CSEDs) and NQ panelboards. HOM250PSPD for Homeline load centers and combination devices (CSEDs)

**Feature** — Plug-on Neutral connectivity. Easy to install, no wiring needed.

**Installation Flexibility** — NEMA 1 (Indoor)

**Surge Current Capacity** — 50 kA

**Standards** — UL Listed 1449, 4th Edition and CSA Certified

**Warranty** — 5 Year/\$50,000 Connected Equipment Limited Warranty

### Hard-Wire Whole House Surge Protective Device (SDSA1175)

- **Use** — Suitable for Use in Service Entrance locations: Meets Requirements of NEC Article 280
- **Feature** — Coordinated Fuse Technology
- **Installation Flexibility** — NEMA 4X (Indoor and Outdoor)
- **Surge Current Capacity** — 36 kA
- **Standards** — UL Listed 1449, 4th Edition and CSA Certified
- **Warranty** — 2 Years



QO2175SB

**Surgebreaker for QO (QO2175SB) and Homeline (HOM2175SB)**

- **Use** — QO2175SB for QO load centers, combination devices and NQ panelboards. HOM2175SB for Homeline load centers and combination devices
- **Installation Flexibility** — NEMA 1 (Indoor)
- **Surge Current Capacity** — 22.5 kA per phase
- **Standards** — UL Listed 1449, 4th Edition and CSA Certified
- **Warranty** — 3 Year/\$10,000 Connected Equipment Limited



HOM2175SB

**Home Electronics Protective Device (HEPD25, HEPD50, HEPD80)**

- **Use** — Small, affordable whole house surge suppression that can easily be mounted to Square D and competitors load centers
- **Installation Flexibility** — NEMA 4X (Indoor and Outdoor). Easy-to-install, optional flush mount kit for a professional look when installed in a finished wall (HEPD25MKF, HEPD58MKF).
- **Surge Current Capacity** — 25 kA (HEPD25), 50 kA (HEPD50) and 80 kA (HEPD80)
- **Standards** — UL Listed 1449, 4th Edition and CSA Certified
- **Warranty** — 3 Year/\$30,000 (HEPD25) or 3 Year/\$50,000 (HEPD50) or 5 Year/\$75,000 (HEPD80) Connected Equipment Limited Warranty



HEPD25

**Surgebreaker Plus Whole House Surge Protector (SDSB80111)**

- **Use** — Mounts directly to any load center from any manufacturer
- **Feature** — Removable modules (cable, Ethernet, and telephone) allow quick and easy installation customization
- **Installation Flexibility** — NEMA 1

(Indoor)

- **Surge Current Capacity** — 80 kA
- **Standards** — UL Listed 1449, 4th edition
- **Warranty** — 5 Year/\$100,000 Connected Equipment Limited Warranty



SDSB80111

# Enclosed Devices

Designed to be tough, reliable, and help provide exceptional performance in the most grueling conditions.

Provides a dead front housing for circuit breakers, molded case switches, and motor circuit protectors to help prevent personnel from accidentally contacting energized parts. Protect circuit breaker from physical damage. Allow circuit breaker operation without removing cover.

## Features

Residential Circuit Breaker Enclosures:

- QOM2 circuit breaker enclosures
- UL Listed
- 100-225 A Max. QOM2 circuit breakers
- 22 k RMS short circuit current ratings
- Ideal for 100–225 A residential applications with Square D load centers, CSED meter mains, and circuit breaker enclosures
- Provides the flexibility to meet more applications with a single breaker format, which also simplifies inventory stocking
- A compact and flexible 2020 NEC compliant residential service entrance device
- NEMA Type 1 and Type 3R enclosures

## Product Description

These devices include provisions for a double-pole circuit breaker to be installed in an enclosure. Typical applications include a main service entrance disconnect for mobile homes and residences, as well as equipment or outbuilding disconnects.



QO2100BNS



QO2100BNRB

### Type

Enclosed molded case circuit breakers are UL Listed; File E136861, for enclosures and File E10027 for circuit breakers. Enclosed molded case switches are UL Listed under File E59921.

### Knockouts

Located in back, side, top and bottom of all devices

### Service

- 120/240 Vac, 1Ø3W
- 240 Vac, 1Ø2W
- 240 Vac, 1Ø3W
- 240/120 Vac, 3Ø4W
- 208Y/120 Vac, 3Ø4W

### Bolt-On Hubs

- Hubs available from 0.75 in. (19 mm) to 2.50 in. (64 mm) conduit size
- Off-center thread openings keep conduit close to wall
- No gasket required with hubs

### Neutral Assemblies

- Insulated and groundable (except QO2TR)
- Suitable for aluminum or copper wire
- Grounding terminal provided

### Equipment Grounding Bar

- Field-installable PKOGTA2
- Suitable for #6 AWG 2/0 aluminum or #10 AWG 2/0 AWG copper wire

### Ratings — (Single Phase)

- QO (2-pole): 10,000 A
- QOM2: 22,000 A
- QB: 10,000 A
- QD: 25,000 A
- QG: 65,000 A
- QJ: 65,000 A @ 240 V or 100,000 A @ 208Y / 120

### Circuit Breakers

Visi-Trip indication (QO circuit breakers). Lugs suitable for aluminum or copper wire. Refer to catalog sections listed below:

- QO Class 730
- QB, QD, QG and QJ Class 734
- QOM2 Class 736
- Molded-case switches Class 601

## Enclosures

### Indoor Enclosures



#### Indoor Enclosures — NEMA Type 1

**Material, Finish and Knockouts** — Enclosures are from sheet steel with knockouts at top, bottom, back and sides. Indoor finish consists of gray baked enamel electrodeposited over cleaned, phosphatized steel.

**Flush and Surface Covers** — Indoor covers are available in surface or flush mount and are included with our enclosed device.

**Provisions** — Indoor devices have padlock provisions for locking circuit breaker handle in ON (I) or OFF (O) position.

### Rainproof Enclosures



#### Rainproof Enclosures — NEMA Type 3R

**Material, Finish and Knockouts** — Enclosures are from galvanized sheet steel with knockouts at bottom, back and sides. Rainproof finish consists of gray baked enamel, electrodeposited over cleaned, phosphatized, galvanized steel.

**Provisions** — Rainproof devices have provisions to padlock cover closed and for interchangeable bolt-on hubs.

# Service Entrance Devices

**Table 75 - Residential Enclosed Circuit Breaker with PowerPacT Q-Frame Molded Case Circuit Breakers**



QO2150MRBE

Enclosure	Mains Rating	Short Circuit Rating	General Purpose	Included In Package
Rainproof NEMA 3R	150 A	25 kA	Q2150MRBE	Factory Installed: (1) QDL22150 (1) Service entrance barrier (1) Emergency disconnect label & (1) Service disconnect label
Rainproof NEMA 3R	200 A	25 kA	Q2200MRBE	Factory Installed: (1) QDL22200 (1) Service entrance barrier (1) Emergency disconnect label & (1) Service disconnect label
Rainproof NEMA 3R	70–200 A	10–100 kA	Q2200RBE <sup>(126)</sup>	Factory Installed: (1) Emergency disconnect label & (1) Service disconnect label Factory Included: (1) Service entrance barrier <sup>(127)</sup>

**Table 76 - Replacement Kit for Residential Enclosed Circuit Breaker with PowerPacT Q-Frame Molded Case Circuit Breakers**

Mains Rating	Short Circuit Rating	Commercial Reference	Included In Package
70–200 A	10–100 kA	PKSB1Q2	(1) Service entrance barrier & (1) Emergency disconnect label <sup>(126)</sup>

**Table 77 - PowerPacT Q-Frame Molded Case Circuit Breakers for Residential**



QBL22070

Service	Type 3R — Rainproof Circuit Breaker not included	Ampere Rating	Short Circuit Rating			
			10 k AIR	25 k AIR	65 k AIR	100 k AIR
2P 240 Vac Maximum	Q2200RBE	70 A	QBL22070	QDL22070	QGL22072	QJL22073
		80 A	QBL22080	QDL22080	QGL22080	QJL22080
		90 A	QBL22090	QDL22090	QGL22090	QJL22090
		100 A	QBL22100	QDL22100	QGL22100	QJL22100
		110 A	QBL22110	QDL22110	QGL22110	QJL22110
		125 A	QBL22125	QDL22125	QGL22125	QJL22125
		150 A	QBL22150	QDL22150	QGL22150	QJL22150
		175 A	QBL22175	QDL22175	QGL22175	QJL22175
200 A	QBL22200	QDL22200	QGL22200	QJL22200		

<sup>(126)</sup>Suitable ONLY for breakers from 70-200 A. Not compatible with 225 A breakers.  
<sup>(127)</sup>Suitable only for 2P Q-frame molded case circuit breakers only.

## Non-Service Entrance Devices

**Table 78 - Enclosed Molded Case Switch, Switch Included (Does NOT provide overcurrent protection)**



QO200TRNM

Service		Ampere Rating	General Purpose	Rainproof	Box No.
240 Vac		60 A (129), (130)	QO260NATS	QO200TR	2, 9R (131)
				QO200TRNM	1NM
				QO260NATR	1R
120/240		100 A (132)	QO2000NS	QO2000NRB	13, 10R

**Table 79 - Enclosed GFCI Circuit Breakers, GFCI Circuit Breaker Included — 10 kA Short Circuit Current Rating**



HOME250SPA

Service	Ampere Rating	Type 3R— Rainproof Circuit Breaker Included	Circuit Breaker Only	Box No.
120/240 Vac	50 A	QOE250GFINM	QO250GFI	1NM (Non metallic)
		HOME250SPA	HOM250GFI	1M (Metallic)
	60 A	QOE260GFINM	QO260GFI3W	1NM (Non metallic) 1M (Metallic)

**Table 80 - 2-Pole Circuit Breaker Enclosures — 22 kA Short Circuit Current Rating**



QO3100BNF

Service	Ampere Rating	General Purpose	Rainproof	Box No.
120/240 Vac	100 A	QO2100BNF/S	QO2100BNRB	13, 10R
	125 A	QO2125BNF/S	QO2125BNRB	18, 13R
60 A Max. Circuit Breaker Enclosures—10 kA, Short Circuit Current Rating Circuit breaker not included. (Order separately from QO Plug-On Circuit Breakers). Will not accept QO-GFI circuit breaker nor QO circuit breakers with factory-installed accessories.				
240 Vac	60 A	—	QO2TR	9R

(128) See QO/Homeline Enclosure Dimensions and Knockout Information, page 67.

(129) Not suitable for service equipment.

(130) Maximum 10 hp 240 Vac.



(131) Top endwall has no hub opening.

(132) Maximum 20 hp 240 Vac.

(133) Not for use with one pole QO circuit breakers. Circuit breakers not included. Accepts QO circuit breakers with factory-installed accessories. Order equipment ground bar PKOGTA2, if required.

(134) Order F for flush, S for surface.

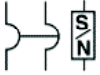
**Table 81 - Q-Frame Enclosures and Q-Frame Circuit Breakers**

Service		Enclosure Only			Circuit Breaker (Order Separately)				
		Type 1 General Purpose	Type 3 Rainproof	Box No.	Ampere Rating	10 k AIR	25 k AIR	65 k AIR	65 k AIR
2P 240 Vac		Q22200NS or Q23225NF/S	Q22200NRB or Q23225NRB	19, 11R, 20, 12R	70 A	QBL22070	QDL22070	QGL22070	QJL22070
					80 A	QBL22080	QDL22080	QGL22080	QJL22080
					90 A	QBL22090	QDL22090	QGL22090	QJL22090
					100 A	QBL22100	QDL22100	QGL22100	QJL22100
					110 A	QBL22110	QDL22110	QGL22110	QJL22110
					125 A	QBL22125	QDL22125	QGL22125	QJL22125
					150 A	QBL22150	QDL22150	QGL22150	QJL22150
					175 A	QBL22175	QDL22175	QGL22175	QJL22175
					200 A	QBL22200	QDL22200	QGL22200	QJL22200
					225 A	QBL22225	QDL22225	QGL22225	QJL22225
3P 240 Vac		Q23225NF/S	Q23225NRB	20, 12R	70 A	QBL32070	QDL32070	QGL32070	QJL32070
					80 A	QBL32080	QDL32080	QGL32080	QJL32080
					90 A	QBL32090	QDL32090	QGL32090	QJL32090
					100 A	QBL32100	QDL32100	QGL32100	QJL32100
					110 A	QBL32110	QDL32110	QGL32110	QJL32110
					125 A	QBL32125	QDL32125	QGL32125	QJL32125
					150 A	QBL32150	QDL32150	QGL32150	QJL32150
					175 A	QBL32175	QDL32175	QGL32175	QJL32175
					200 A	QBL32200	QDL32200	QGL32200	QJL32200
					225 A	QBL32225	QDL32225	QGL32225	QJL32225

**Table 82 - QOM2 Enclosures and QOM2 Circuit Breakers**

Service		Enclosure Only			QOM2 Circuit Breaker (Order Separately)	
		Type 1 General Purpose	Type 3 Rainproof	Box No.	Ampere Rating	22 k AIR
		Cat. No.	Cat. No.			Cat. No.
2P 240 Vac Max.		QOM22225NF/S	QOM22225NRB	22, 16R	100 A	QOM2100VH
				22, 16R	125 A	QOM2125VH
				22, 16R	150 A	QOM2150VH
				22, 16R	175 A	QOM2175VH
				22, 16R	200 A	QOM2200VH
				22, 16R	225 A	QOM2225VH

(135) Order F for flush, S for surface.

(136) Equipment ground bar kit PKOGTA2 factory-included.

(137) See QO/Homeline Enclosure Dimensions and Knockout Information, page 67.

(138) DE3A Discount Schedule.



Schneider Electric  
800 Federal Street  
Andover, MA 01810  
USA

888-778-2733

[www.se.com](http://www.se.com)

As standards, specifications, and design change from time to time, please ask for confirmation of the information given in this publication.

© 2023 – 2026 Schneider Electric. All rights reserved.

1100CT0501