

# Wiser Radiator Thermostat 2nd Generation

## Wiser Home Device user guide

Information about features and functionality of the device.

05/2026



# Legal Information

The information provided in this document contains general descriptions, technical characteristics and/or recommendations related to products/solutions.

This document is not intended as a substitute for a detailed study or operational and site-specific development or schematic plan. It is not to be used for determining suitability or reliability of the products/solutions for specific user applications. It is the duty of any such user to perform or have any professional expert of its choice (integrator, specifier or the like) perform the appropriate and comprehensive risk analysis, evaluation and testing of the products/solutions with respect to the relevant specific application or use thereof.

The Schneider Electric brand and any trademarks of Schneider Electric and its subsidiaries referred to in this document are the property of Schneider Electric or its subsidiaries. All other brands may be trademarks of their respective owner.

This document and its content are protected under applicable copyright laws and provided for informative use only. No part of this document may be reproduced or transmitted in any form or by any means (electronic, mechanical, photocopying, recording, or otherwise), for any purpose, without the prior written permission of Schneider Electric.

Schneider Electric does not grant any right or license for commercial use of the document or its content, except for a non-exclusive and personal license to consult it on an "as is" basis.

Electrical equipment should be installed, operated, serviced, and maintained only by qualified personnel. No responsibility is assumed by Schneider Electric for any consequences arising out of the use of this material.

Schneider Electric reserves the right to make changes or updates with respect to or in the content of this document or the format thereof, at any time without notice.

**To the extent permitted by applicable law, no responsibility or liability is assumed by Schneider Electric and its subsidiaries for any errors or omissions in the informational content of this document, as well as any non-intended use or misuse of the content thereof.**

---

# Table of Contents

Table of Contents .....	3
Safety Information.....	4
About the Document.....	5
Wiser Radiator Thermostat 2nd Generation .....	9
About the device.....	10
Installing the device .....	10
Pairing with the Wiser Hub .....	11
Configuring the device .....	15
Setting the device location .....	15
User interface lock settings.....	15
Locating the device .....	16
Selecting the battery type .....	17
Selecting the battery type manually .....	17
Calibrating the device.....	18
Using the device.....	19
Setting the room temperature manually .....	19
Using the thermostat as a standalone device .....	19
Operating the device using the Wiser Home app .....	21
Setting the room temperature using the app .....	21
Creating a Schedule/Event .....	23
Editing Schedule/Event .....	26
Built-in Automation.....	27
Voice control.....	30
Creating a Moment .....	31
Creating an Automation.....	35
Removing the device from the Wiser Home app .....	43
Resetting the device .....	43
Replacing the batteries .....	45
LED indications .....	46
Troubleshooting .....	47
Technical Data .....	47

# Safety Information

## Important Information

Read these instructions carefully and look at the equipment to become familiar with the device before trying to install, operate, service, or maintain it. The following special messages may appear throughout this manual or on the equipment to warn of potential hazards or to call attention to information that clarifies or simplifies a procedure.



The addition of either symbol to a “Danger” or “Warning” safety label indicates that an electrical hazard exists which will result in personal injury if the instructions are not followed.



This is the safety alert symbol. It is used to alert you to potential personal injury hazards. Obey all safety messages that accompany this symbol to avoid possible injury or death.

### **DANGER**

**DANGER** indicates a hazardous situation which, if not avoided, **will result in** death or serious injury.

**Failure to follow these instructions will result in death or serious injury.**

### **WARNING**

**WARNING** indicates a hazardous situation which, if not avoided, **could result in** death or serious injury.

### **CAUTION**

**CAUTION** indicates a hazardous situation which, if not avoided, **could result in** minor or moderate injury.

### **NOTICE**

NOTICE is used to address practices not related to physical injury.

# About the Document

## Document Scope

This document provides detailed information on the features and functionality of the Wiser Radiator Thermostat 2nd Generation, including pairing with the Wiser Hub, configuration and using the device. The guide also explains how to create schedules, and automate functions. Additionally, it includes troubleshooting tips, technical data, compliance information, and instructions for resetting the device. The content of this document helps the home owners and the professional installers to install the Wiser Radiator Thermostat 2nd Generation.

## Validity Note

The characteristics of the products described in this document are intended to match the characteristics that are available on [www.se.com](http://www.se.com). As part of our corporate strategy for constant improvement, we may revise the content over time to enhance clarity and accuracy. If you see a difference between the characteristics in this document and the characteristics on [www.se.com](http://www.se.com), consider [www.se.com](http://www.se.com) to contain the latest information.

## For your safety

<b>NOTICE</b>
<b>RISK OF DAMAGE TO DEVICE</b> Always operate the product in compliance with the specified technical data. <b>Failure to follow these instructions can result in equipment damage.</b>
<b>⚠ CAUTION</b>
<b>HAZARD OF INJURY/EQUIPMENT DAMAGE</b> <ul style="list-style-type: none"><li>• Do not use Lithium and Zinc disposable batteries.</li><li>• Risk of explosion if battery is replaced by an incorrect type.</li><li>• Dispose of used batteries according to the instructions.</li></ul> <b>Failure to follow these instructions can result in injury or equipment damage.</b>
<b>NOTICE</b>
<b>RISK OF DAMAGE TO DEVICE</b> <ul style="list-style-type: none"><li>• Do not use tools, such as pliers, for installation.</li><li>• Make sure that the O-ring is seated firmly in the thread. Tighten the ring nut by hand only.</li></ul> <b>Failure to follow these instructions can result in equipment damage.</b>

## General Cybersecurity Information

In recent years, the growing number of networked machines and production plants has seen a corresponding increase in the potential for cyber threats, such as unauthorized access, data breaches, and operational disruptions. You must, therefore, consider all possible cybersecurity measures to help protect assets and systems against such threats.

To help keep your Schneider Electric products secure and protected, it is in your best interest to implement the cybersecurity best practices as described in the Cybersecurity Best Practices document.

Schneider Electric provides additional information and assistance:

- Subscribe to the Schneider Electric security newsletter.
- Visit the Cybersecurity Support Portal web page to:
  - Find Security Notifications.
  - Report vulnerabilities and incidents.
- Visit the Schneider Electric Cybersecurity and Data Protection Posture web page to:
  - Access the cybersecurity posture.
  - Learn more about cybersecurity in the cybersecurity academy.
  - Explore the cybersecurity services from Schneider Electric.

## Secure disposal / End of Life / Decommission

If a device needs to be disposed of, perform a factory reset to delete all data, project data, and programming is deleted from the device. Make sure that it is securely disposed to prevent its redeployment into your operational system or unauthorized use.

## Environmental Data

Find and download comprehensive environmental data about your products, including RoHS compliance and REACH declarations as well as Product Environmental Profile (PEP), End-of-Life instructions (EOLI) and much more.

<https://www.se.com/myschneider>



### General information about Schneider Environmental Data Program

Click the link below to read about Schneider Electric's Environmental Data Program.

<https://www.se.com/ww/en/about-us/sustainability/environmental-data-program/>



## Declaration of Conformity

Hereby, Schneider Electric Industries SAS, declares that this product is in compliance with the essential requirements and other relevant provisions of RADIO EQUIPMENT DIRECTIVE 2014/53/EU.

Declaration of conformity can be downloaded on:

- <https://www.go2se.com/ref=CCTFR6110>
- <https://www.go2se.com/ref=WV704R0A6901>
- <https://www.go2se.com/ref=CCTFR6111>
- <https://www.go2se.com/ref=WV704R0A6902>

## Available Languages of the Document

The document is available in these languages:

- English
- German

## Information on Non-Inclusive or Insensitive Terminology

As a responsible, inclusive company, Schneider Electric is constantly updating its communications and products that contain non-inclusive or insensitive terminology. However, despite these efforts, our content may still contain terms that are deemed inappropriate by some customers.

## Trademarks

This guide makes reference to system and brand names that are trademarks of their relevant owners.

- Zigbee® is a registered trademark of the Connectivity Standards Alliance.
- Apple® and App Store® are brand names or registered trademarks of Apple Inc.
- Google Play™ Store and Android™ are brand names or registered trademarks of Google Inc.
- Wi-Fi® is a registered trademark of Wi-Fi Alliance®.
- Wiser™ is a trademark and the property of Schneider Electric, its subsidiaries and affiliated companies.
- Amazon Alexa™ is a trademark of AMAZON TECHNOLOGIES, INC.
- QR Code is a registered trademark of DENSO WAVE INCORPORATED in Japan and other countries.
- Google Home™ is a trademark of Google INC.

Other brands and registered trademarks are the property of their respective owners.

## Wiser Radiator Thermostat 2nd Generation



CCTFR6110, WV704R0A6902



CCTFR6111, WV704R0A6901

## About the device

The Wiser Radiator Thermostat 2nd Generation (hereinafter referred to as **Thermostat**) uses integrated temperature sensors to control the flow of water through a radiator, thereby regulating the temperature in a room. The target temperature and switching times are set by using the Wiser app.

Adding thermostats to your Wiser systems allows you to control schedules and temperatures in each room enabling personalized heating. This can help reduce energy usage significantly. The Thermostat provides individual room control with ultimate comfort, convenience, and practicality.

### Thermostat features:

- Twist-top radiator thermostat cap
- Device user interface lock

### Thermostat features in app:

- Mobile control anytime, anywhere with the Wiser app
- Works with Amazon Alexa and Google Assistant
- Full transparency with Insights and the Heat Report
- Smart modes for maximum energy efficiency

## Operating elements

- A. Status LEDs
- B. Radiator Thermostat cap
- C. Ring nut (only used with M30 x 1.5 mm valve adapter)

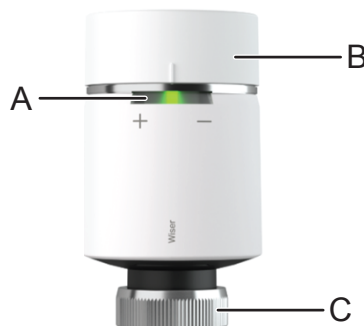

## Installing the device

Refer to the installation instruction supplied with this product.

Installation manual link:

- [Installation instructions.](#)

## Pairing with the Wiser Hub

You must insert the batteries in the thermostat. For more information, refer [Selecting the battery type manually, page 17](#).

**TIP:** Upon inserting the batteries, the thermostat automatically calibrates the radiator valve.

1. On the **Home** screen, tap .
2. Tap **Devices** >  and tap **Climate** > **Radiator Thermostat**.

**NOTE:** Alternatively, tap **Control** >  > **Climate** > **Radiator Thermostat**.  
The next screen shows the joining process of the thermostat.

3. Tap **Scan QR code** and allow the Wiser Home app to access your camera. Then, scan the QR code located on the device.

**IMPORTANT:** If you have a QR code, tap **I have QR code**, if you do not have a QR code, tap on **I don't have QR code** and pair the device manually and proceed to step4.

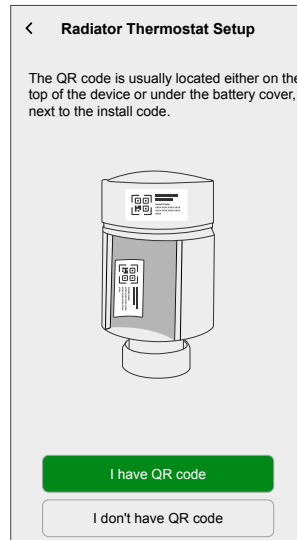

If the QR code is incorrect, a message **Incorrect QR code scanned** will appear. Tap **I can't scan the QR code** and choose one of the following options:

- **(A):** Enter the MAC Address and Install Code, then tap **Connect**. The app will verify if the MAC address and Install code are valid.
- **(B):** Tap this option if you are unable to find the MAC address and Install code. Then tap **Yes, continue** and proceed to Step 4.

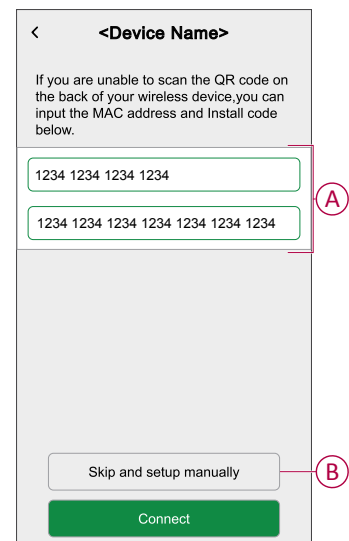

4. Twist and hold the radiator thermostat cap in the + direction.  
After 3 seconds, LED flashes green.

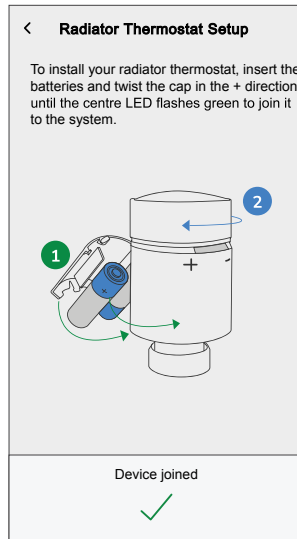
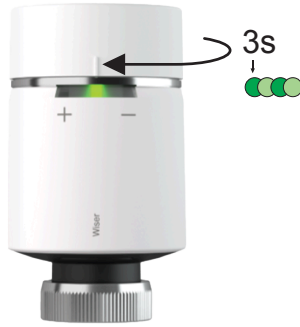

**NOTE:** In the app, you can see that the thermostat has been successfully joined.

5. This screen displays the thermostat calibration procedure. If you want to calibrate the thermostat, follow the procedure below. Otherwise, tap **Next** to continue.

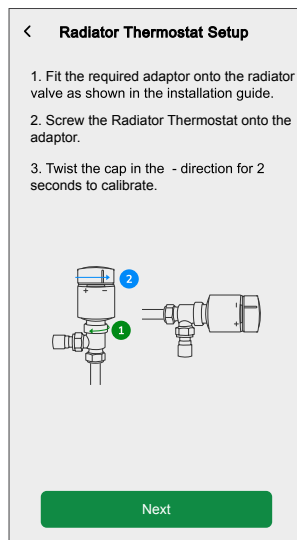

6. Tap **Next** to enter a thermostat name and assign to an existing or a new room. After you successfully pair the thermostat, the following options appear:
- **+ Add New Device:** Tap to continue pairing more devices.
  - **Start Using Your Device:** Tap to start using the thermostat.

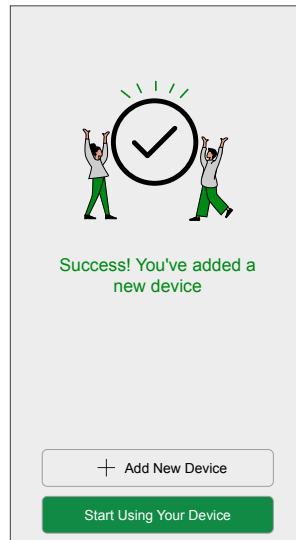

**NOTE:** The app shows that you have added a new device. This screen appears only if you are logged in as a home owner, not as a professional installer.

The thermostat is now listed on the **Control** tab under the **All** and the specific room tabs.

## Configuring the device



**IMPORTANT:** The temperature data from the Radiator Thermostat sensor will be used as an input for the room's heating system. If a room has an additional temperature measuring device (such as a Room Thermostat, Connected Thermostat (2A or 16A), or Temperature & Humidity Sensor), the system uses that device for temperature measurement because it is typically placed in a more representative location than the radiator thermostat. Finally, if a room has multiple temperature measuring devices (Room Thermostat, Connected Thermostat (2A or 16A), or Temperature & Humidity Sensor), the system calculates the average temperature measured from all devices to control the heating based on the overall room temperature.

- If several Radiator Thermostats are installed in a room, the system uses the average temperature of all Radiator Thermostats.

For more details, refer to the [Setting the device as temperature source](#).

## Setting the device location

You can add your device to any room (such as bedroom, living room, dining room etc.).

1. On the **Home** screen, tap .
2. Tap **Devices**, select the device from the list for which you wish to change the location.
3. Tap **Location**  to open setup screen.
4. On the **Device Setup** screen, you can enter **New room name** (A) or select an existing room from the list (B).

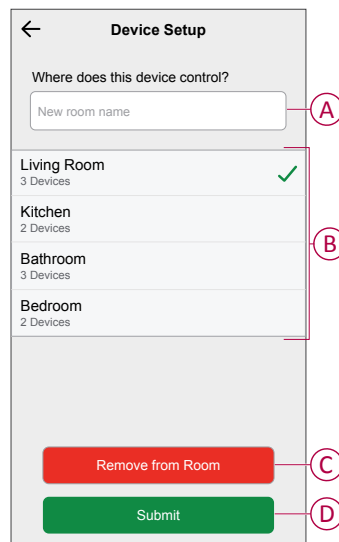

**TIP:** If the device is already assigned, you can remove it from the existing room. Tap **Remove from Room** (C).

5. Once changes are done, tap **Submit** (D).

## User interface lock settings

Using the Wiser Home app, you can lock the thermostat controls. This prevents any changes in set temperature, when the thermostat cap is twisted.

1. On the **Home** screen, tap .
2. Tap **Devices > Radiator Thermostat > enable/disable Device lock** toggle switch (A) to lock/unlock thermostat control.

**TIP:** When the thermostat is locked, a lock icon (B) appears.

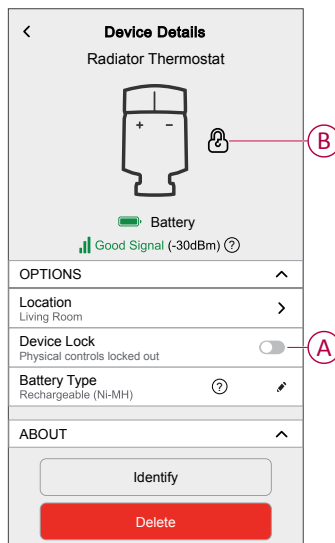

## Locating the device

Using the Wiser Home app, you can locate a Thermostat from the other available devices in the room.

1. On the **Home** screen, tap .
2. Tap **Devices > Radiator Thermostat > Identify** (A).

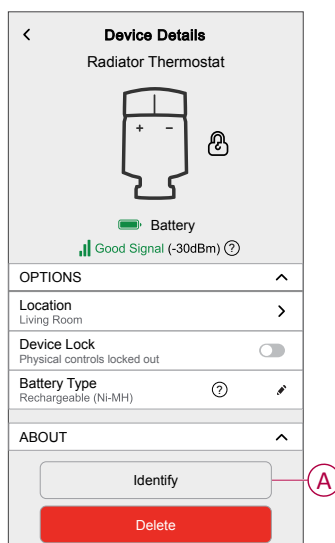

**NOTE:** The Thermostat LEDs flashes, so you can identify the actual device. It may take up to a minute to start and flash the Thermostat LED. The Thermostat LEDs will continue to flash until you tap OK.



## Selecting the battery type

Using the Wiser Home app, you can select the type of battery which is being used for the thermostat.

**NOTE:** You must correctly select the type of battery inserted in the thermostat, in order to get the correct information about the battery life.

1. On the **Home** screen, tap .
2. Tap **Devices > Radiator Thermostat > Battery Type**  icon (A) and select the type of the battery from the following options:
  - Rechargeable - HR6 NiMH
  - Non-Rechargeable - LR6 Alkaline

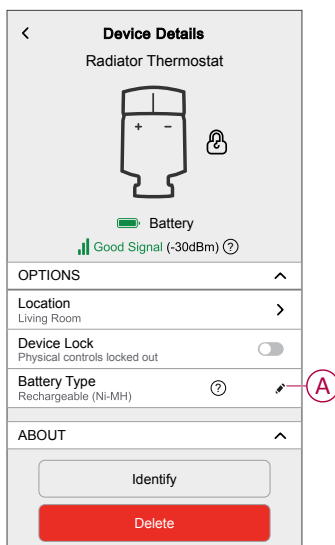



## Selecting the battery type manually

When the batteries are inserted in the thermostat, all the LEDs on it flash. During this time, you can manually select the type of the battery inserted in it.

**NOTE:** You must correctly select the type of battery inserted in the thermostat, in order to get the correct information about the battery life.

To select the battery type, gently twist the radiator thermostat cap in + direction and release.

Repeat this until you see the indication for the correct battery type:

	<p>Red center LED indicates that the rechargeable battery (HR6 NiMH) is selected.</p>
	<p>No center LED indicates that the non-rechargeable battery (LR6 Alkaline) is selected.</p>

## Calibrating the device

The thermostat automatically calibrates the radiator valve by adjusting the pin position about five minutes after the batteries are inserted. The calibration takes only a few seconds. When the thermostat is mounted on the radiator, you may hear the motor operating during calibration.

**NOTE:** The motor sound will not be audible if the thermostat is not attached to the radiator.

Under certain operating conditions, the thermostat automatically performs periodic self-calibration to ensure accurate valve movement.

If you notice that the thermostat valve position seems incorrect, you can manually recalibrate it:

1. Rotate the radiator thermostat cap in the + direction until the red LED glows and the motor starts to drive. After a few seconds, the motor stops and all LEDs start flashing, indicating that the thermostat has entered calibration mode.
2. Again, rotate the radiator thermostat cap in the - direction until the motor starts driving again. After a few seconds, all LEDs flash, indicating that the calibration is completed.



## Using the device

### Setting the room temperature manually

The room temperature can be increased/decreased manually by twisting the radiator thermostat cap.

#### Twist the radiator thermostat cap:

- In the + direction: Increases the temperature. The red LED glows for 5 seconds.
- In the - direction: Decreases the temperature. The blue LED glows for 5 seconds.

Every twist changes the setpoint temperature by  $\pm 2$  °C from the current room temperature. This boost remains active for 1 hour.

**NOTE:** If the setpoint temperature is already more than 2 °C above or below the room temperature, the change will not adjust the setpoint temperature.

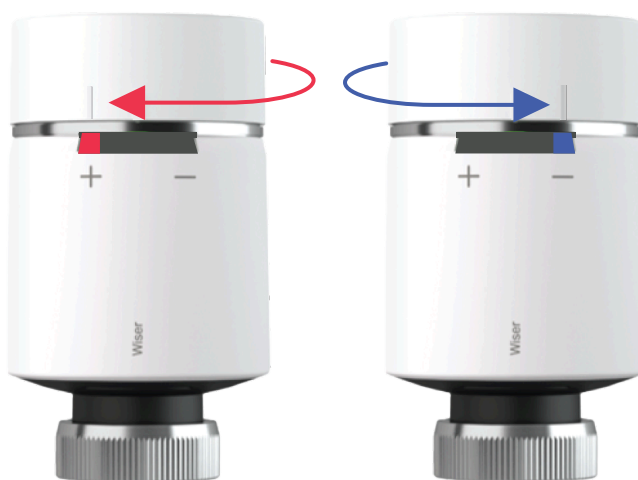

### Using the thermostat as a standalone device

The room temperature can be increased/decreased without pairing the thermostat with the Wiser Hub. In this case, the thermostat operates as a standalone device. In the standalone mode, the thermostat sets the default setpoint temperature to 20 °C.

To adjust the setpoint temperature:

## 1. Twist the radiator thermostat cap:

- In the + direction: Increases the temperature by 4 °C.
- In the - direction: Decreases the temperature by 4 °C.

When the setpoint temperature is adjusted, the LEDs turn On for a few seconds. The LED indications are as follows:



LED State			Temperature setpoint °C
Red LED (Left)	Green/Red LED (Centre)	Blue LED (Right)	
Off	Off	Off	8
Off	Off	On	12
Off	Green	On	16
Off	Green	Off	20
On	Green	Off	24
On	Off	Off	28

## Operating the device using the Wiser Home app

In the Wiser Home app, the device control screen give you quick access to all essential functions of your thermostat. You can enable or edit a schedule, add the thermostat to favorites, switch the thermostat on or off and so on.

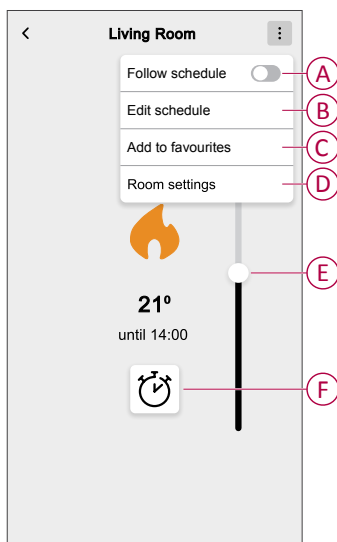
On the **Control** tab, select the thermostat. The device control screen displays the following options:



<b>A</b>	Tap the toggle switch to enable the device to follow the schedule.
<b>B</b>	Tap to enter the <b>Schedule</b> screen, where you can edit or create a new schedule.
<b>C</b>	Tap to add the device to the <b>Favorite devices</b> section in the <b>Home</b> screen. To know more about <b>Favourites</b> , refer to the <b>Managing Favourites</b> topic in the System User Guide.
<b>D</b>	Tap to control other settings from the <b>Device Settings</b> screen.
<b>E</b>	Move the slider (E) up or down to adjust the setpoint temperature.
<b>F</b>	<p>Tap the  (boost icon) (F) to set a time duration for which the setpoint temperature will increase by 2 °C.</p> <p>When you tap the  (boost icon) (F), you can choose one of the following time durations:</p> <ul style="list-style-type: none"> <li>• 30 min</li> <li>• 1 hr</li> <li>• 2 hr</li> <li>• 3 hr</li> <li>• Off</li> </ul>

## Setting the room temperature using the app

Using the Wiser Home app, you can adjust, set or boost the room temperature.

1. On the **Control** tab, tap **All Devices** or select the room where the thermostat is installed.
  - a. Use the slider to adjust the temperature.

**NOTE:** A  indicates that the room temperature is below the setpoint, and heating is currently ON.

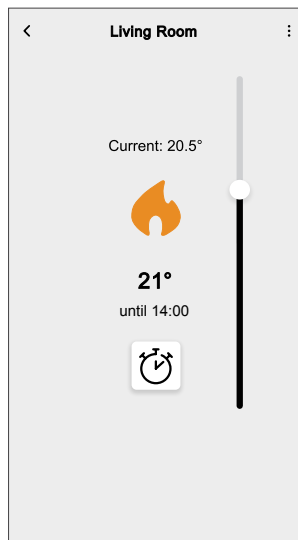

You can tap the boost icon to set a time duration for which the setpoint temperature will increase by 2 °C.

**IMPORTANT:**

- Moving the slider to the bottom activates **Frost Protection** mode, which maintains the room temperature at 5 °C to prevent freezing.

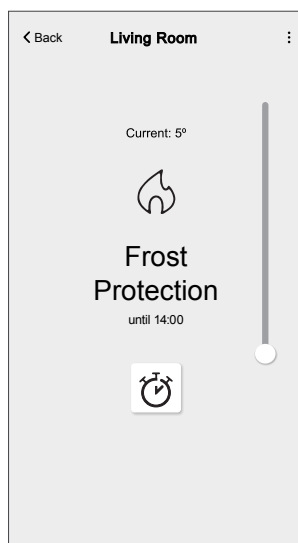

**TIP:** You can also adjust the temperature on the **control** tab by tapping + or – in the Heating section of the selected room.

**NOTE:** If your Wiser System has only one device, the Control tab will not appear. All functions will be available on the Home screen.



- b. Tap  to set the time period to increase the setpoint temperature.

**IMPORTANT:** Once this time is set, the setpoint temperature increases by 2 °C for the set boost time. After the boost, the setpoint temperature returns to the scheduled event or to the previous setpoint temperature.

**NOTE:** You can stop the boost at any time by tapping  and turning it off.

## Creating a Schedule/Event

Schedule/Event allows you to control how your thermostat behaves throughout the day. Once the schedule is set, your system will follow the active schedule. You can create or modify the schedules at any time.

1. On the **Home** screen, tap .
2. Tap **Schedules** tab > .
3. On the **New Schedule** page, enter the **Schedule name**, select **TYPE**, and select room.
4. Tap **Create**.

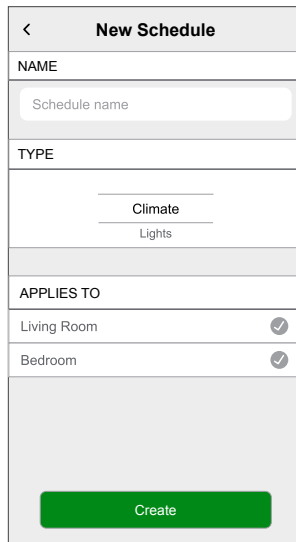

New Schedule	
NAME	
Schedule name	
TYPE	
<input type="radio"/> Climate	
<input type="radio"/> Lights	
APPLIES TO	
Living Room	<input checked="" type="checkbox"/>
Bedroom	<input checked="" type="checkbox"/>
Create	

5. Select any day (A) and tap  to add an event:
- **TEMPERATURES:** Select the desired temperature (for example 16 °C).  
**NOTE:** If you move the slider to the bottom of the bar for the schedule, Frost Protection Mode will activate when the schedule begins. In Frost Protection Mode, the system maintains the room temperature at 5 °C to prevent freezing.
  - **WHEN:** Set the time for the event (for example 12:00)  
**NOTE:** You can create a maximum of 8 events per day.

**Copy Schedule:** You can tap  to copy the schedule from one day to other days or copy the entire schedule to a new schedule or to an existing one.

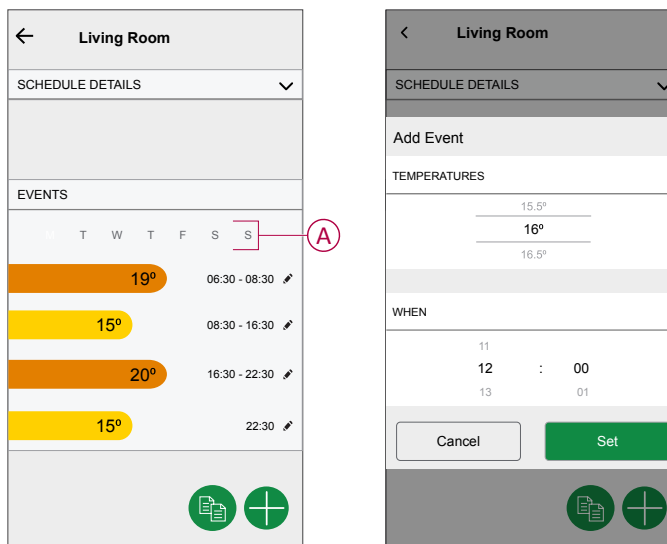

6. Tap **Set**.
7. On the top-right corner of the screen, tap  and select **Follow schedule** toggle switch to turn on/off the schedule.

## How setpoint changes work

When your system is following a schedule:

- The new setpoint remains active until the next scheduled event.
- You can view the time until which a schedule is active, on the **Control** tab under the device name. This indicates how long the current schedule will stay ON.

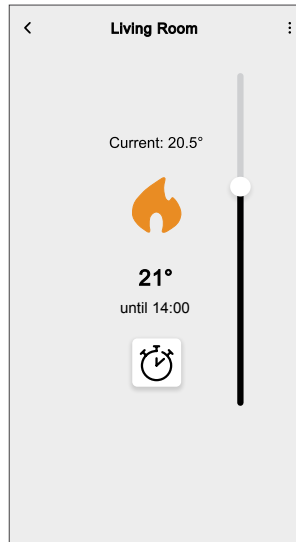

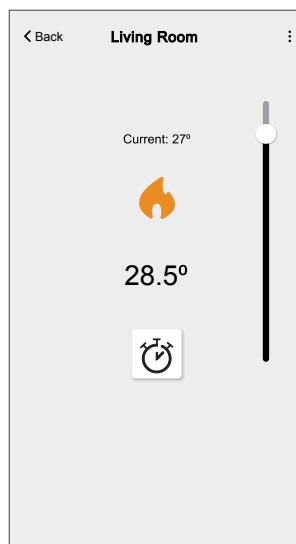

When your system is not following a schedule:

- Any changes made using the slider remains active until you adjust the slider again.
- The time until which a schedule is active will not be displayed on the screen.



## Editing Schedule/Event

1. On the **Home** screen, tap .
2. Tap **Schedules** tab and select the schedule that you want to modify.
3. Tap **SCHEDULE DETAILS**:
  - rename the device
  - change the device location
  - delete schedule
4. To edit the **EVENTS**, select a day, and tap  to change the time and temperature.

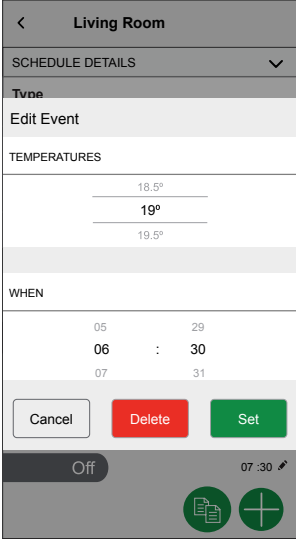

**Living Room**

SCHEDULE DETAILS ▾

**Type**

Edit Event

TEMPERATURES

18.5°

19°

19.5°

WHEN



05 29

06 : 30

07 31

Cancel Delete Set

Off 07:30 ↗

 

## Built-in Automation

There are three built-in Automation such as Boost All, Cancel all overrides and Away mode.

### Boost All

You can apply a +2 °C boost for 1 hour to all rooms in the system. This action does not affect hot water. Since it is a one-time action, you will find **Boost All** (A) under the **Automation** menu by tapping the **Automations** tab at the bottom of the **Home** screen.

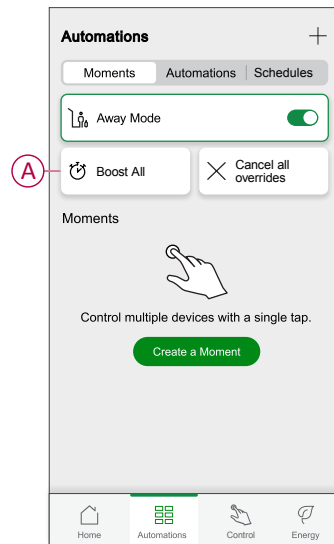

## Cancel all overrides

The **Cancel all overrides** (A) option returns all heating to pre-set values. If you have selected **Boost All** or manually changed a room setpoint, this action will cancel those overrides and restore all rooms to their scheduled setpoints. You can find this option in the **Automations** menu by tapping the **Automations** tab at the bottom of the **Home** screen.

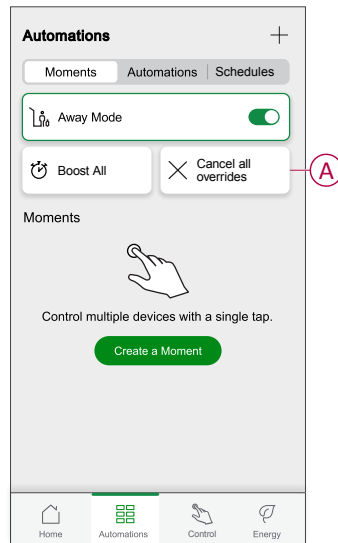

## Away Mode

**Away Mode (A)** sets all rooms to a default temperature (16 °C). It appears with a check mark in the **Automation** page when active and can be accessed from the **Automation** menu by tapping the **Automation** tab at the bottom of the **Home** screen.

Only rooms with setpoints higher than 16 °C will change. For example, a room set to 5 °C will remain unchanged.

**Away Mode** overrides **Boost** and **schedules**, but you can still manually adjust setpoints, boost individual rooms, or turn hot water ON.

When active, rooms and hot water display **Away Mode** values, and hot water will turn OFF if selected in the **Away Mode** screen. For more information on Away Mode, refer to the **Away Mode** topic in the respective System User Guide

**NOTE:** Current temperature is not shown while **Away Mode** is active.

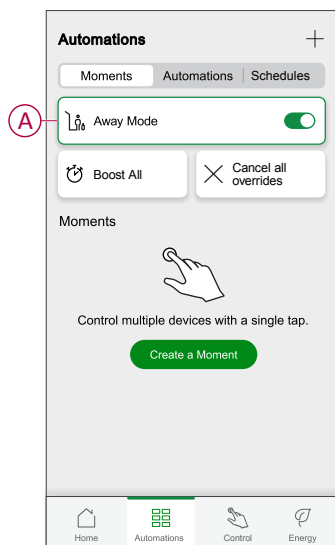

## Voice control

You can control the thermostat using Amazon Alexa® and Google home by giving a voice command.

### Amazon Alexa™

Amazon Alexa™ (Alexa) is an intelligent personal assistant developed by Amazon™, and is capable of voice interaction.

#### Common Wiser commands for Alexa

- Discover Devices: “Alexa, discover devices”
- Reduce Temperature: “Alexa, decrease the temperature upstairs by 4 degrees”
- Increase Temperature: “Alexa, increase the temperature upstairs by 3 degrees”
- Set Temperature: “Alexa, set the upstairs to 20 degrees”
- Get Temperature: “Alexa, what is the temperature upstairs?”
- Get the Setpoint: “Alexa, what is the upstairs set to?”

### Google Home™

Google Home™ is a brand of smart speakers that work similarly to Amazon’s Alexa. The user can speak a large number of commands to request information, or ask Google Assistant to perform action.”

Common Wiser commands for Google Home™:



- Inquiry: “OK, Google, is the hot water on?”
- Hot Water Command: “OK, Google, turn on/off the hot water”
- Room Temperature: “OK, Google, how warm is (room name)?”
- Set Temperature: “OK, Google, set (room name) to XX degrees”
- Increase Temperature: “OK, Google, increase the setpoint by XX degrees”
- Set Temperature: “OK, Google, set (room name) to XX degree”

### Changes made with Google Home™

All changes requested through voice command is valid for one hour, or until the next scheduled event overrides. The user cannot change this action. This also applies for boosts initiated from the thermostat.

## Creating a Moment

A Moment allows you to change the state of multiple devices with a single tap. Moments act like scenes, allowing you to control several devices all at the same time.

1. On the **Home** screen, tap .
2. Go to **Moments** >  to create a moment.
3. Enter the name of the moment (A).

**TIP:** You can choose the cover image that best represents your moment by tapping .

4. Tap **Add actions** (B) to select the list of devices.

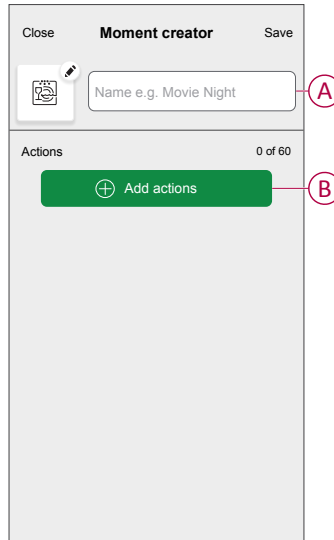

5. In the **Select devices** menu, you can select the devices (C).

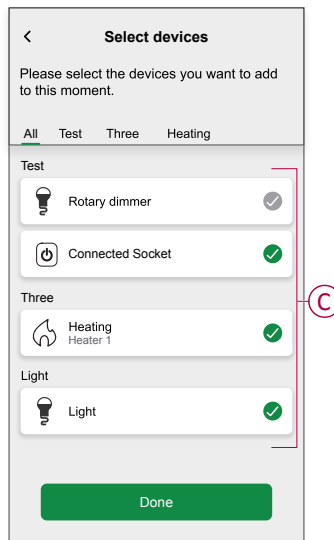

6. Once all the devices are selected, tap **Done**.

7. On the **Moment creator** page, select the device to set the condition. For example, select heating.

- Set the required temperature using the slider (D).

**NOTE:** If you move the slider to the bottom of the bar, **Frost Protection** mode is activated. In this mode, the system maintains the room temperature at 5 °C.

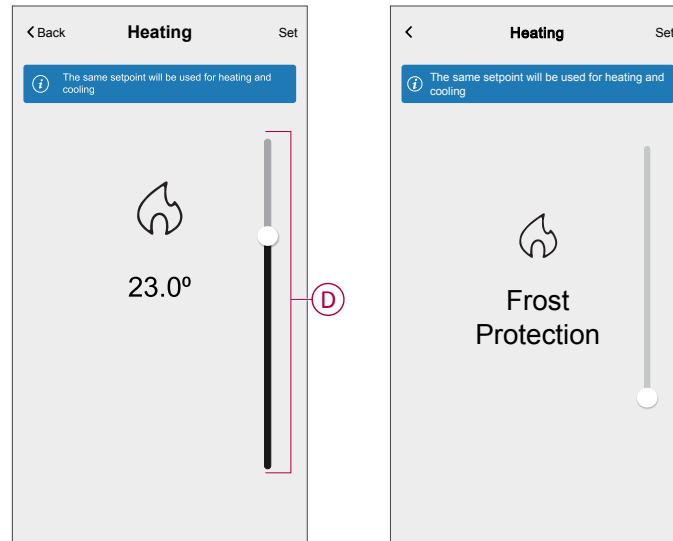

When the desired condition is set, tap **Set**.





8. Once all conditions are set, tap **Save**.

Once the moment is saved, it is visible on the **Moments** tab. You can tap on the moment to enable it.

**TIP:**

- If you want to see the created moments on the **Home** screen, go to **Home** >  > **Home** screen > **Moments**. Enable the toggle button to view moments on the **Home** screen.
- You can also rearrange the moments by tapping **Edit** from the **Moments** tab on the **Home** screen, or by tapping **Automation** > **Moments** > **Reorder**.

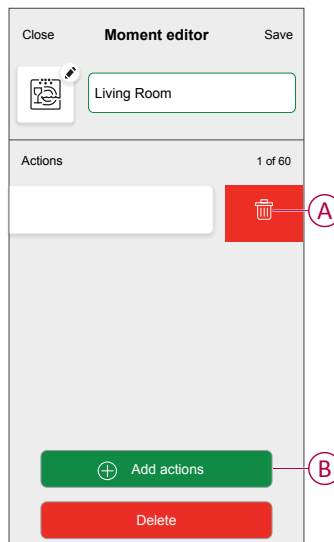

## Editing a moment

1. On the **Home** screen, tap **Automations** .
2. Go to **Moments**, locate the moment you want to edit and tap .
3. On the **Moment editor** screen, you can perform following changes:
  - Change the image for the moment .
  - Rename the moment.
  - Tap each action to change the settings.
  - To remove an action, slide the action to the left and then tap  (A) to delete it.
  - Tap  **Add actions** (B) to add new action.



4. Tap **Save** to save the changes.

## Deleting a moment

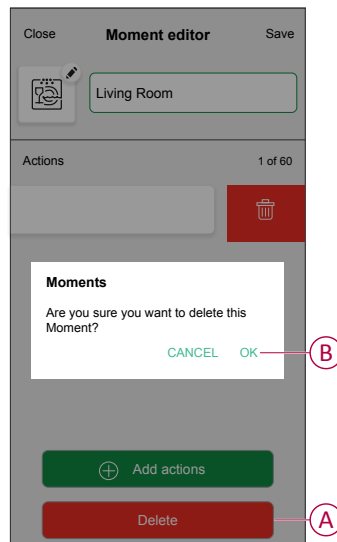

1. On the **Home** screen, tap **Automations** .
2. Go to **Moments**, locate the moment you want to delete and tap .

3. On the **Moment editor** screen, tap **Delete** (A) and then tap **OK** (B).



## Creating an Automation

An automation allows you to group multiple actions that are usually done together, triggered automatically or at scheduled times.

1. On the **Home** screen, tap .
2. Go to **Automation** >  to create an automation.  
**NOTE:** Maximum 10 automations can be added.
3. Tap **If (A)** and select any of the following conditions (B):
  - **All conditions:** This triggers an action only when all conditions are met.
  - **Any condition:** This triggers an action when at least one condition is met.

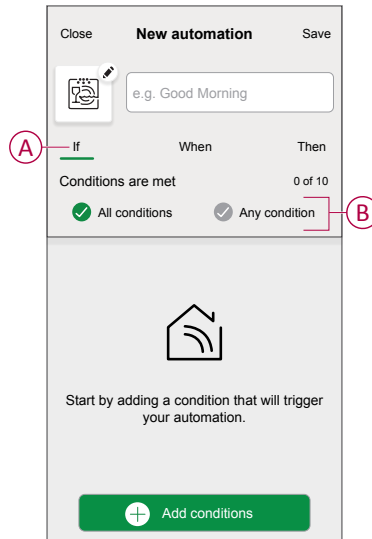

4. Tap **Add conditions** and select any of the following (C):
  - **Device status change:** Select a device to enable automation.
  - **Away Mode:** Enable/Disable away mode to trigger an action.

**TIP:** Away mode can also be used as a trigger to turn off the lights, dimmer or closing the shutter etc. For more information about **Away Mode**, refer to the System User Guide.

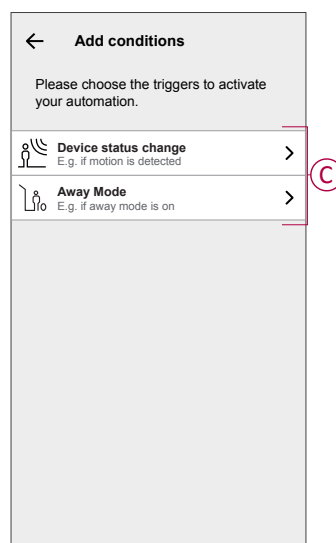

5. Tap **Device status change** > . Set the temperature using sliding bar (D) and select the condition (E) (**less than / more than**), then tap **Set**.

**NOTE:** If you move the slider to the bottom of the bar, Frost Protection mode is activated. In this mode, the system maintains the room temperature at 5 °C.

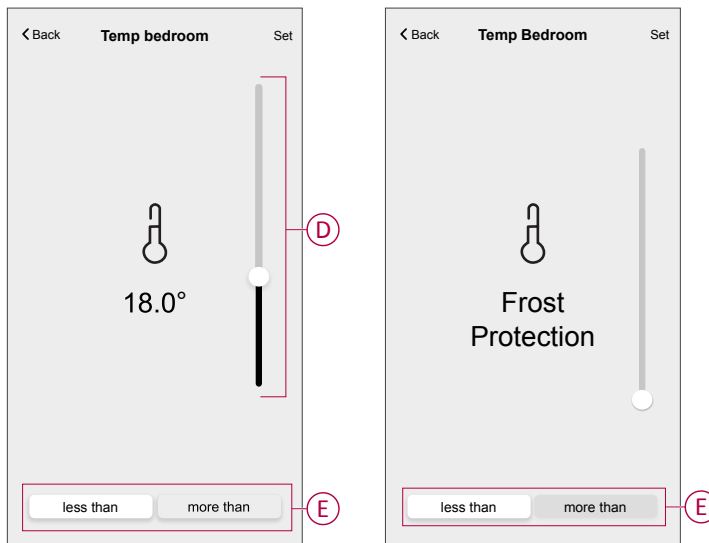

**NOTE:**

- Maximum 10 conditions can be added.
- To remove an added condition, swipe left and tap .

6. To set a specific time for your automation, tap **When** > **Add time** and select any of the following (F):

- **Specific time of the day: Sunrise, Sunset, Custom.**
- **Period of time: Daytime, Night time, Custom.**

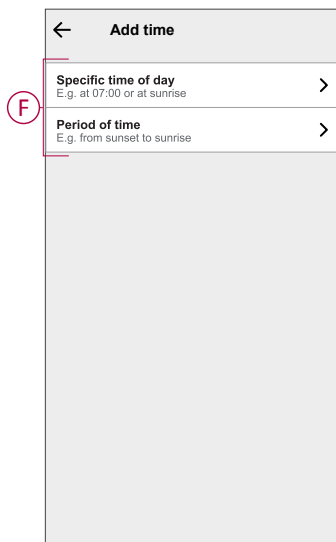

**NOTE:**

- Maximum 10 entries can be added
- To remove a specific time, swipe left and tap .

7. To add an action, tap **Then > Add an action** and select any of the following (G):
- **Control a device:** Select a devices that you want to trigger.
  - **Send Notification:** Turn on the notification for the automation.
  - **Activate a moment:** Select the moment that you want to trigger.
  - **Wait:** This option allows you to add a delay in an automation sequence. You can set the wait time in increments of 1 (hour/minute), up to a maximum of 24 hours. This feature is useful for delaying actions within an automation.

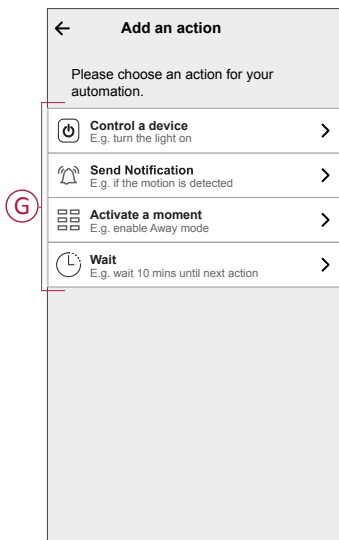

8. Tap **Control a device > Heating** and select any of the following (H):
- **Boost:** Set the duration to increase the temperature by 2 °C.
  - **Setpoint:** Set the desired temperature.

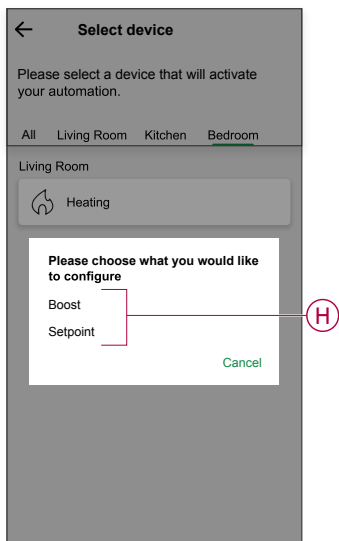

9. Tap **Setpoint**, set the required temperature using vertical sliding bar (I), then tap **Set**.

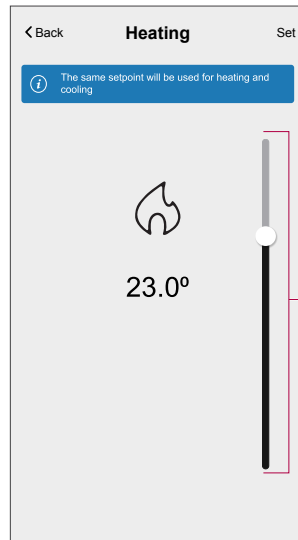

**NOTE:**

- Maximum 10 actions can be added.
- To remove an action, swipe it left on the action and then tap .

10. Enter the automation name (J).

You can choose the cover image that represents your automation by tapping

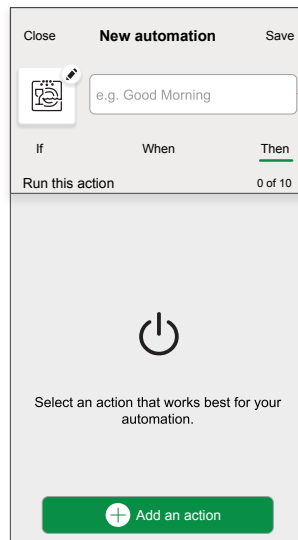

**11. Tap Save.**

Once the automation is saved, it is visible on the **Automation** tab.

Using the  (K) you can enable and disable the automation.

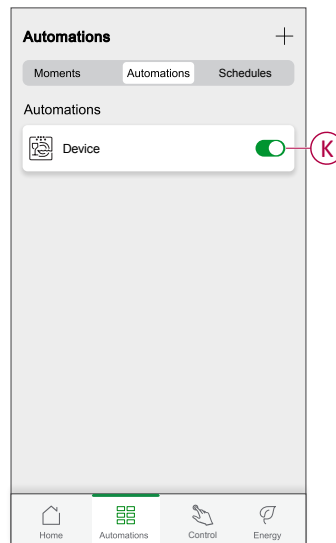

## Example of an automation

This demonstration guides you through setting up an automation that activates heating to a set temperature of 20 °C when the room temperature drops below 18 °C.

**NOTE:** To ensure proper heating control, you must create two separate automations:

- Automation 1: Boost the heating when a presence is detected in the room.
- Automation 2: Turn off the heater when the room temperature reaches 25 °C or higher.

The room heater will not turn off automatically until you create another automation.

1. Go to **Automation** > **+** to create an automation.
2. To add a condition, tap **Add Condition** > **Device status change** > **Temperature/Humidity Sensor** > **Temperature**.

- Set the temperature as 18 °C (A) and the condition as **less than** (B) and tap **Set**.

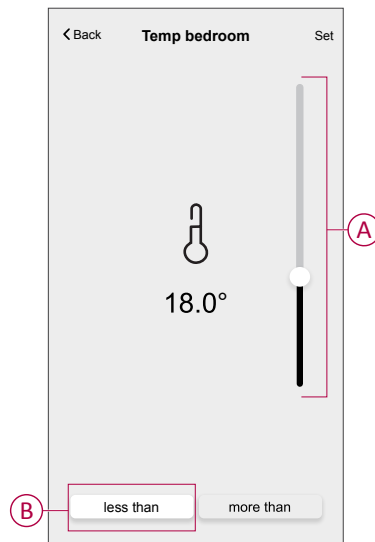

- Read the information and tap **OK**.
- To add an action, tap **Then > Add an action > Control a device > Heating > Setpoint**. Set the temperature to 20 °C (C), then tap **Set**.

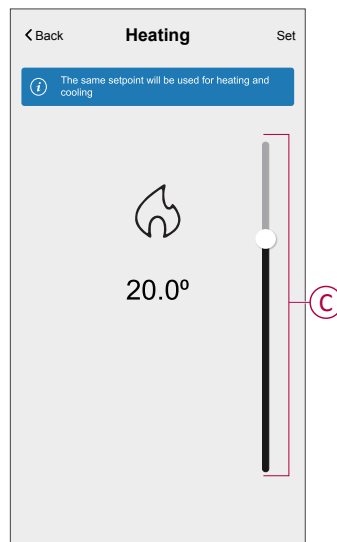

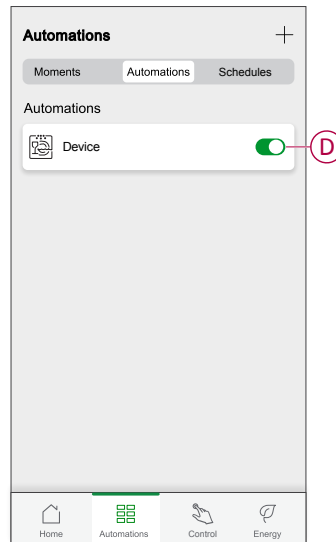

- Read the information and tap **OK**.
- Enter the name of the automation.  
**TIP:** You can choose the cover image that represents your automation by tapping .

8. Tap **Save**.  
Once the automation is saved, it is visible on the **Automation** tab.



**NOTE:** You can enable or disable saved automations on the **Automations** tab by using  (D).

## Editing an automation

1. On the **Home** screen, tap **Automations** .
2. Go to **Automation**, tap the automation you want to edit.
3. On the **Edit automation** screen, you can perform the following changes:
  - Change the image of the automation .
  - Rename the automation.
  - Tap each condition to change the settings.
    - To remove a condition, slide the condition towards left and then tap  (A) to delete it.
    - Tap **Add conditions** (B) to add new condition.
  - To change the order of actions, tap the **Then** option, and hold an action, then drag and drop to the desired position.

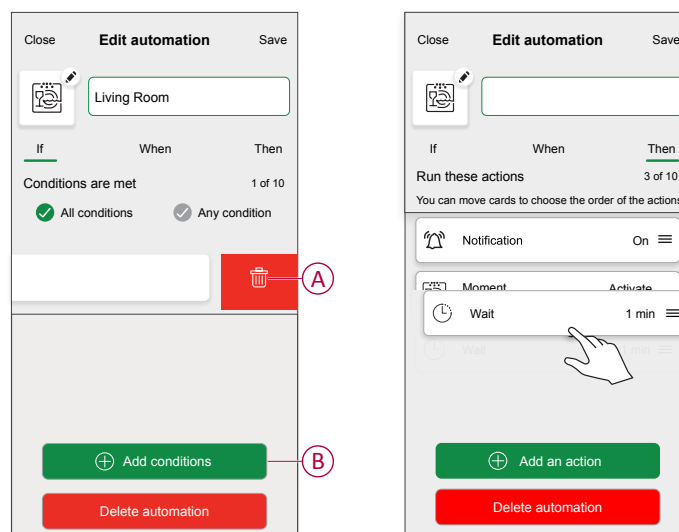

4. Tap **Save** to save the changes.

## Deleting an automation

1. On the **Home** screen, tap **Automations** .
2. Go to **Automation**, tap the automation you want to delete.

- On the **Edit automation** screen, tap **Delete automation** (A) and read the confirmation message and then tap **OK** (B).

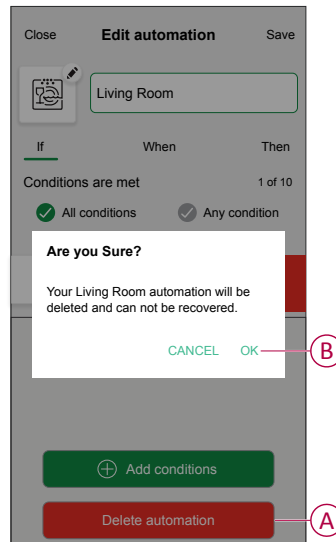

## Removing the device from the Wiser Home app

- On the **Home** screen, tap .
- Tap **Devices > Radiator Thermostat > Delete** (A).

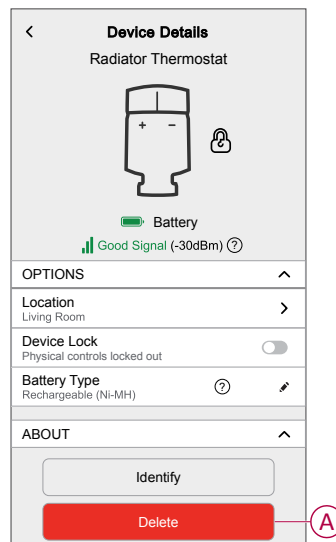

## Resetting the device

You can reset the Thermostat to factory default when it is attached to the radiator body. It can be reset manually at any time, e.g., when the Wiser Hub is replaced.

- Twist and hold the radiator thermostat cap in the “-” direction, after a few seconds, the center LED starts flashing red.

2. Continue holding the radiator thermostat cap in the “-” direction until the LED turns solid red indicating that the thermostat has been successfully reset.



## Replacing the batteries

Replace the batteries when they are low or critically low. The center LED on the thermostat shows when the batteries need replacing.

If rechargeable NiMH batteries are installed in the thermostat, remove the battery by gently press and remove the battery cover and recharge them with a battery charger.

LED			
Left	Centre	Right	Meaning
Off	Solid Red for 1s, once per hour.	Off	Battery low. Replace soon.
Off	Flashes Red for 5s, once per minute.	Off	Batteries critically low. Replace immediately.

1. Gently press and remove the battery cover.
2. Use two 1.5 V AA alkaline batteries (non-rechargeable) or HR6 NiMH rechargeable batteries.  
Ensure that the batteries are inserted with the correct orientation. The polarity symbols (+ and -) are indicated on the device terminals and inside the battery cover.

**TIP:** After replacing the batteries, wait a few minutes for the thermostat to calibrate automatically. If automatic calibration does not occur, perform a manual calibration. For more details, see [Calibrating the device](#), page 18 topic.

### NOTICE

#### BATTERY SELECTION AND USE

- Use only standard, non-rechargeable AA Alkaline batteries or rechargeable HR6 NIMH batteries.
- Do not use Zinc Carbon or Zinc Chloride batteries

**Failure to follow these instructions can result in equipment damage.**

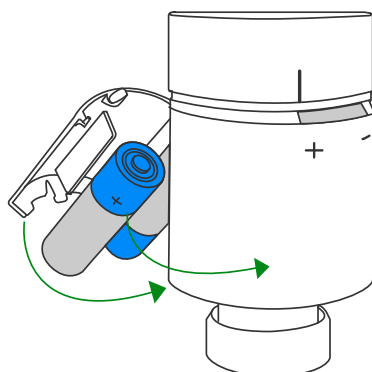

**NOTE:** Batteries should be disposed off according to statutory regulations. They must be recycled as per WEEE standards.









**TIP:** After the batteries are replaced, the device automatically calibrates. If it does not occur, perform manual calibration. For more information, refer to the [Calibrating the device](#), page 18 topic.

## LED indications





### Normal use

State	User Interaction	Left LED	Center LED	Right LED	Duration
Boost up	Twist the radiator thermostat cap in the + direction				Solid for 5 seconds
Boost down	Twist the radiator thermostat cap in the - direction				Solid for 5 seconds

### Head calibration

State	User Interaction	Left LED	Center LED	Right LED	Duration
Install mode	The radiator thermostat fully opens and holds for install on a radiator.				Red and Blue: flash for up to 5 minutes
					NiMh batteries selected
					No LED indication when alkaline batteries selected
Joining	Twist and hold the radiator thermostat cap in the + direction for 3 seconds				Pulses for up to 2 minutes
Joining success					Solid for 5 seconds
Joining failed	If no network is found after 2 minutes				Flashes for 5 seconds

### Error state

State	User Interaction	Left LED	Center LED	Right LED	Duration
Low battery					Solid for 1 second (Repeated each hour)
Critical battery					Fast flash for 5 seconds (Repeated each minute)
No Signal	Twist the radiator thermostat cap in the + direction to start a boost.				Fast flash for 5 seconds (Repeated)
No Signal	Twist the radiator thermostat cap in the - direction to start a boost.				Fast flash for 5 seconds (Repeated)
No network	Twist the radiator thermostat cap in the + or - direction to start a boost.				Solid with fade-out after 2 seconds. In this event, the radiator thermostat has not joined the wiser system and must either join the hub or be re-installed.

## Troubleshooting

Symptom	Possible cause	Solution
The Thermostat is not responding or the app is not measuring the temperature.	Power failure or Wiser Hub restarted.	Post power failure, Wiser Hub needs up to 15 minutes to recover to normal.
The Thermostat displays offline in the app or the center LED blinks.	<ul style="list-style-type: none"> <li>Poor signal between the Wiser Hub and Thermostat.</li> <li>The batteries need replacing in the Thermostat.</li> <li>The Thermostat has been reset through the human interaction at physical device.</li> </ul>	<ol style="list-style-type: none"> <li>Again repair the Thermostat in the app.</li> <li>Replace the batteries and re-calibrate Thermostat, refer to the Replacing the batteries, page 45 and calibrating the device, page 18</li> <li>Re-configure the Thermostat.</li> </ol>

**TIP:** See also [LED Indications](#), page 46– understanding LED status and corresponding corrective actions.

## Technical Data

Power supply	2 x 1.5 V IEC LR6 (AA) alkaline batteries or 2 x HR6 NiMH batteries
Without power supply	Connection data are retained
Temperature setting range	5 °C - 30 °C
Temperature resolution	0.5 °C
Control accuracy	< 0.8 °C at 4 °C/h
Surface temperature at place of installation	max. 93 °C
Water temperature	max. 110 °C, max. continuous 73 °C
Ambient operating temperature	0 °C to 45 °C
Storage temperature	-20 °C to 65 °C
Operating frequency	2.4 GHz
Max. radio frequency power transmitted	max. 20 mW (13 dBm)
Degree of contamination	2
Radio range	30 m free field
Specification	Value
Energy class	IV - 2%
Software class	A
Protection rating	IP 30
Dimensions (HxØ)	93 x 51 mm

Schneider Electric  
35 rue Joseph Monier  
92500 Rueil Malmaison  
France

[www.se.com](http://www.se.com)

As standards, specifications, and design change from time to time, please ask for confirmation of the information given in this publication.

© 2025 – 2026 Schneider Electric. All rights reserved.

DUG\_Wiser Radiator Thermostat 2nd Generation\_WH-01